



Solar modules



Solar module mounting instructions

Mono S4 • Mono S3 • Mono S2 • M series • P series

Solar module mounting instructions

Mono S4 ▪ Mono S3 ▪ Mono S2 ▪ M series ▪ P series



Table of

1. Safety instructions	5
■ General safety instructions	5
■ Applicable safety regulations	5
■ Using the modules	5
■ Attention: Danger to life!	5
■ Electrical installation	6
■ Transport, intermediate storage and safe unpacking	6
2. Installation of the module	7
■ Ensuring safe installation	7
■ Ensuring that the modules are properly earthed	7
■ Special instructions for handling AR glass modules	8
■ Technical explanation of the cell production process used in the manufacture of 'All Black' modules	8
■ Ensuring comprehensive fire protection	9
■ Ensuring a suitable environment	9
■ Suitable installation situation	9
■ Correct mounting location	9
■ Assuring yield through optimum alignment and inclination	9
■ Installing the module free from shade	9
■ Ensuring sufficient rear ventilation	9
■ Secure mounting	10
■ Instructions for installation	10
■ Loads	10
■ Proper cabling	11
■ Ensuring correct connection	11
■ Using suitable materials only	11
■ Mounting variants	12
■ Protecting the cables from damaging environmental influences	14
■ Ensuring that the plug connectors are installed correctly	14
■ Maintenance and cleaning	14
■ Instructions for disassembly	15
■ Disposal of the modules	15
■ Note on liability and status of the instructions	15
3. Notes	16

Subject to technical changes and changes in product design.

The technical information about the product applicable at the time of manufacture of the product shall apply.

Solar Fabrik GmbH, Laufach, Germany, 2023

Solar module mounting instructions

Mono S4 ▪ Mono S3 ▪ Mono S2 ▪ M series ▪ P series



Mono S4

[108 half cells]

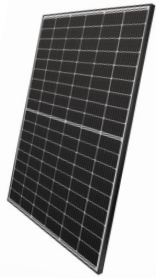

[120 half cells]



[144 half cells]

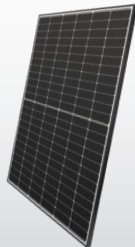

Mono S3

[120 half cells]

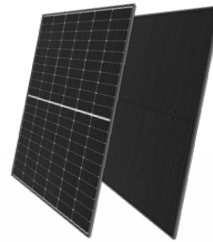

[120 bifacial half cells]

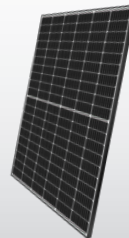

[144 half cells]

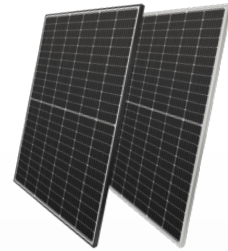

Mono S2

[60 full cells]

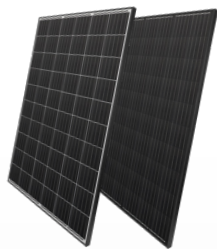

[120 half cells]

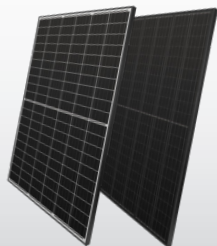

[72 full cells]



[144 half cells]

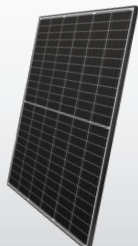

Solar module mounting instructions

Mono S4 ▪ Mono S3 ▪ Mono S2 ▪ M series ▪ P series



M Serie

[60 full cells]

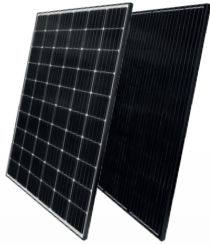

[72 full cells]

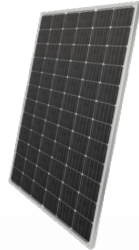

[120 half cells]

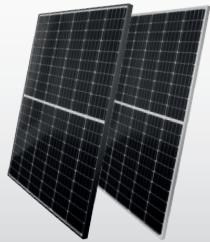

P Serie

[60 full cells]

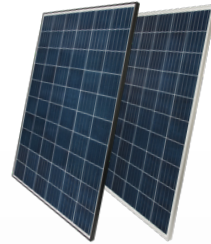

[72 full cells]

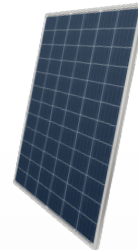

Solar module mounting instructions

Mono S4 ▪ Mono S3 ▪ Mono S2 ▪ M series ▪ P series

1. Safety instructions

General safety instructions

Repair and operation of a PV system require sound expert knowledge. Therefore, all work on the system may only be carried out by appropriately qualified and authorised technical specialists. It is essential to read these mounting instructions carefully and attentively before installing, commissioning or maintaining the PV system, and keep the instructions easily accessible. Non-observance of the safety instructions can lead to personal injury and damage to property. Keep children away!

We are constantly striving for the further improvement of our products through innovation and research activity.

We therefore reserve the right to change the information contained in this mounting manual without prior notice.

Applicable safety regulations

The modules of the system may only be used in accordance with their suitability. The modules may not be technically modified. During mounting, make sure that the locally applicable building regulations, standards and accident prevention regulations are observed. Ensure that the necessary safety instructions for mounting and operation of other system components are also followed.

Using the modules

Please note the following points in particular when using our solar modules:

- The installation and/or operation of the solar modules is permitted up to a max. altitude of 2000 m above sea level.
- The function of the modules is tested at an ambient temperature of -40 to +85°C. This range should be observed.
- The modules must not be exposed to exceptional chemical loads (e.g. emissions from manufacturing companies).
- When connecting solar modules to power storage units, the respective safety instructions of

the manufacturer must be observed.

Attention: Danger to life!

Danger to life from electric shock!

Solar modules generate electricity. If they are exposed to light, they are live and can pose a danger. Even if the voltage of a single module is still low at less than 50 V DC, the total voltage adds up as soon as several modules are connected in series. When several modules are connected in parallel, the currents add up. Although the fully insulated plug contacts provide protection against accidental contact, the following must be observed when handling the solar modules to avoid fire, sparking and, above all, fatal electric shock:

- Do not insert electrically conductive parts into the plugs and sockets.
- Do not wear metal jewellery during mechanical and electrical installation work.
- Keep moisture away from tools and the working environment. Only install solar modules and cables with dry plugs and sockets.
- Proceed with extreme caution and care.
- Only use insulated tools to carry out all work on the cables and also wear insulated gloves.
- Do not disassemble modules. Never remove parts or type plates attached by the manufacturer. Only use faultless modules. Do not use sharp objects, paints or adhesives on the back of the module.
- Do not expose solar modules to artificially concentrated sunlight.

Please note that the wiring of modules may only be carried out by qualified and authorised specialists.

Solar module mounting instructions

Mono S4 ▪ Mono S3 ▪ Mono S2 ▪ M series ▪ P series

Danger to life due to high voltage!

High contact voltages can still occur in the inverter even when it is disconnected. For this reason, the following applies:

- Exercise extreme caution when working on the inverter and the cables.
- In order for the high-voltage components to discharge, it is essential to observe the time intervals specified by the inverter manufacturer after switching off the inverter and before starting any further work. Always observe the mounting instructions of the inverter manufacturer.

Danger to life from electric arc!

When exposed to light, solar modules produce direct current. If a closed circuit is opened, e.g. when the DC line is disconnected from the inverter under load, a fatal electric arc can occur.

- Under no circumstances disconnect the solar generator from the inverter as long as it is connected to the mains.
- Ensure flawless cable connections.
- Connect cables seamlessly and keep them free from dirt.

Electrical installation

The solar modules are designed for use in PV systems of application class A and can therefore be operated in systems with dangerous direct voltages (greater than 120 V DC according to EN 61730) and power ratings.

PV modules of this application class may be used in systems with unlimited accessibility.

Solar Factory GmbH modules of the Mono S4, Mono S3, Mono S2, M and P series, which are qualified within this application class according to EN 61730, meet the requirements of protection class II when installed in accordance with regulations.

Transport, intermediate storage and safe unpacking

The modules are sensitive technical components that require great care when handled. Be especially careful, therefore, when transporting and temporarily storing the modules and leave them in their packaging until they are used. Always lift and carry the modules with both hands and do not use the junction box as a hand grip.

Do not drop the modules or place them roughly on hard ground or on the module corners. Do not place objects on the modules. Do not stack modules on top of each other without protection.

Avoid bending the modules. Do not step on the modules. Do not work with sharp objects and keep all electrical contacts clean and dry.

It is advisable to note the serial numbers for system documentation. If intermediate storage of the modules is necessary, a dry, ventilated room should be provided.

Clean, non-slip gloves must be worn during all transport and installation work to prevent injury from cuts on module edges. In addition, avoid soiling the solar glass with fingerprints, as they can damage the special coating of the glass.

It is essential to observe the warnings on the packaging and the enclosed unpacking instructions.

Solar module mounting instructions

Mono S4 ▪ Mono S3 ▪ Mono S2 ▪ M series ▪ P series



2. Installation of the module

Ensuring safe installation

Secure yourself and other persons against falls; do not carry out installation work in strong winds and prevent objects from falling if possible. Carefully secure the working area to avoid danger or injury to persons.

Always comply with the permissible maximum mechanical load in accordance with DIN EN 1991-1-3/DIN EN 1991-1-4

Ensure that the maximum mechanical load is not exceeded and take into account any location-dependent loads such as wind or snow. Remember that the module could bend under high load. When using fastening elements, cable ties or comparable connecting materials between the back of the module and the cross profiles, ensure that the module is not damaged by pointed or uneven structures.

Ensuring that the modules are properly earthed

In accordance with the provisions of Solar Fabrik GmbH, it is not necessary to earth the module frames and rack for trouble-free operation. To avoid the risk of electric shock (e.g. from static charges) as far as possible, Solar Fabrik GmbH recommends having the installer carry out professional earthing.

If an external lightning protection device is available, a technical specialist must integrate the PV system in the lightning protection concept while observing country-specific standards and regulations.

A qualified electrician must check the earthing connections between the modules. A qualified electrician must also connect the main earthing.

An earthing method approved by Underwriters Laboratories (UL) is mandatory in the USA and Canada.

For proper earthing, ensure optimum electrical conductivity. For this purpose, earthing holes are provided on the back of the module frame. These earthing holes are marked with a stamped earthing symbol.

Earthing holes are marked with a earthing symbol:

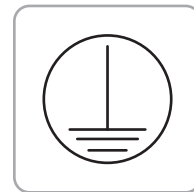

▪ Positions for M/P series

▪ Additional options for Mono S2

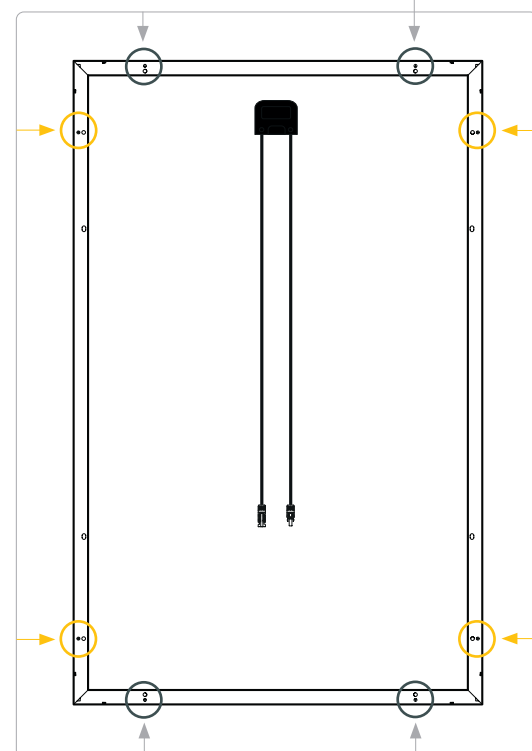

Attach the earthing clamp to one of the specially marked earthing holes on the rear side of the module frame.

Solar module mounting instructions

Mono S4 ▪ Mono S3 ▪ Mono S2 ▪ M series ▪ P series

Correct handling of AR glass modules

The nano-porous coating on the glass surfaces of the solar module reduces reflection losses. Compared to uncoated glass, a deviation of the irradiation angle from the vertical can result in an angle-dependent transmission of up to 2 % more power. To maintain this effect and to avoid visual impairments, we urgently recommend observing the following instructions:

- Handle the modules with care due to the coated glass.
- Handle the modules with care when unpacking and mounting. We recommend only touching the surfaces with clean gloves because the special reflective properties make light soiling easier to detect. Especially grease and oil are visible even in small quantities and can influence the transmission.
- We advise against attaching stickers or labels to the coated surface. Depending on the material used, this can result in very fine residues that are difficult to remove.
- In rare cases, there may be visible white residues of the coating fluid and colour variations in the edge area (≤ 5 mm). These are fully functional modules and there is no reduction in quality.
- If it is necessary to clean the modules due to heavy soiling, we recommend the following procedure:

+ Clean the modules when they have cooled down (e.g. during the morning hours)

+ For moderate to strong residues, we recommend cleaning with lukewarm, de-mineralised water and clean, lint-free cotton cloths, microfibre cloths or paper towels

+ For particularly heavy and stubborn soiling, we recommend detergents containing surfactants

+ Avoid cleaning with strong acids, alkaline solutions, petrol-based cleaners, steam and hot cleaners, cleaners with silicone oils, fluorides or waxes, polishes, alkaline cleaners and cleaners with scouring agents and high-pressure cleaners

+ This so-called anti-reflective coating is subject to coating tolerances, making the colour image of the individual module different; this is most noticeable in diffuse light.

Confirmation can be made that the anti-reflective coating may result in increased power yields and is not a negative quality feature.

The phenomenon of optical differences should get better after the first few years of yield due to climatic conditions, meaning that the system can be operated in combination with these modules without any reservations.

Technical Explanation of the cell production process used in the manufacture of solar modules

1. The cells we use in the production of our panels are classified as 'A-Grade' cells without exception. However, the cell sorting process is undertaken both manually and mechanically. This can already lead to heterogeneous cell colours, which become visible through a black backing film.
2. The cells used are both 166mm x 83mm and 182mm x 91mm Mono Perc P-Type Halfcut cells. These module cells were subjected to a coating thickness tolerance, this process can also result in differences in colour.
3. The cells were also treated with plasma-enhanced chemical vapour deposition (PECVD) during the production process. This separation process guarantees improvements in efficiency. However, it can also result in differences in colour within the blue colour family. Consequently, module cells may be light blue to grey colour.

Independent of these processes, Solar Fabrik modules are tested again by an independent test laboratory. Here, the electro luminescence shows the desired quality characteristics. This guarantees worry-free operation.

Solar module mounting instructions

Mono S4 ▪ Mono S3 ▪ Mono S2 ▪ M series ▪ P series

Ensuring comprehensive fire protection

Under certain circumstances, the installation of roof-mounted systems can have an impact on the fire safety of a building. Improperly executed installations in particular can lead to a fire hazard. As the modules are not explosion-proof equipment, do not install the modules near highly flammable gases and vapours, e.g. in the vicinity of gas containers, paint spraying systems or filling stations. Also, do not install the modules next to naked flames and flammable materials.

It is important that the installation always complies with local conditions, laws and regulations.

Ensuring a suitable environment

The modules are primarily intended for use in moderate climatic conditions. Make sure they are not exposed to artificially concentrated sunlight, submerged or continuously exposed to splashing water at their destination. There is a risk of corrosion if the modules are subject to exceptional loads of salts or sulphur.

Suitable installation situation

It is of utmost importance that the module meets the technical requirements of the overall system. Therefore, make sure that no damaging mechanical or electrical effects (e.g. overvoltage) are exerted on the module by other system components. When connected in series, only modules of the same amperage may be used; when connected in parallel, only modules with the same voltage may be used. The modules may only be operated with the permissible system voltage; operation with a higher voltage is not intended.

Correct mounting location

The module must not be mounted as overhead glazing, e.g. on a facade. In addition to the module itself, the mounting system must also be able to easily withstand the expected load from the conditions at the installation site (snowfall, wind).

The underside of the module frame is provided with

openings that allow precipitation water to run off. During installation, make sure these openings are not restricted in their function.

If used in an upright installation, the socket can be mounted pointing upwards and downwards. Otherwise only installation with the junction box facing upwards is permitted.

Assuring yield through optimum alignment and inclination

We recommend planning the suitable orientation and correct tilt angle of the modules before installation, so that the system can achieve optimum yield performance. Ideal conditions for power generation prevail when the sun's rays hit the generator surface perpendicularly.

To avoid any loss of performance when connected in series, please make sure that all modules are installed with the same orientation and inclination.

Installing the module free from shade

Even slight shading reduces the yield from the system. It is therefore particularly important to install the module as free of shading as possible. There should be no full shading throughout the year, and unhindered exposure to sunlight should be ensured for several hours, even on days when the calendar is unfavourable.

Ensuring sufficient rear ventilation

Sufficient rear ventilation ensures that performance-reducing heat accumulation can be avoided.

Solar module mounting instructions

Mono S4 ▪ Mono S3 ▪ Mono S2 ▪ M series ▪ P series

Secure mounting

In order to mount the modules as intended, they must each be securely fastened by at least four points. Framed PV modules may be clamped on the short and on the long sides.

NOTE: Ensure that the maximum mechanical load capacity of the modules is observed, taking into account the wind and snow load zones as well as the terrain category and building height.

Instructions for installation

The modules can be connected to the substructure in various ways: either by clamping the modules from the front (see example 1) or by screwing the modules into the mounting holes provided from behind (see example 2).

Use a torque wrench during installation. The tightening torque to be applied in the examples shown is 20 Nm. Use M6 V2A screws for installation. Only use the existing drill holes for installation. The drilling of further holes would lead to a loss of warranty.

Loads

Depending on the type of mounting, the solar modules are able to withstand the respective load. In principle, make sure that the solar modules are not subject to unnecessary stress.

When using the clamp-on mounting method (see example 1), the fixing points in extended clamping areas must be taken into account. A graphic representation of the clamping areas can be found on page 10.

Please note that failure to comply will void any claim on corresponding warranty services.

Solar module mounting instructions

Mono S4 ▪ Mono S3 ▪ Mono S2 ▪ M series ▪ P series



Example 1 - Clamping vane

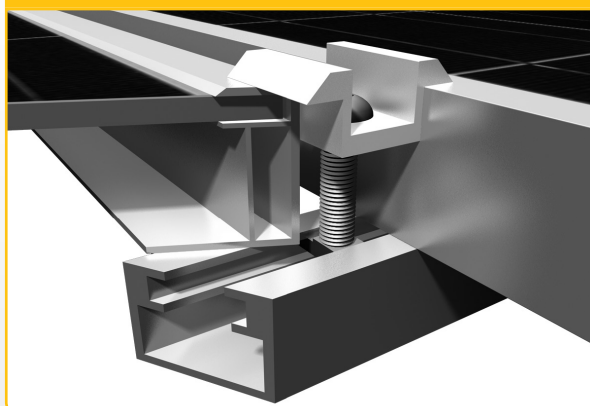

Ensure that the total area of all conductor loops is kept as small as possible to reduce voltages caused by indirect lightning strikes. It is essential to subject the wiring to a thorough final check before the generator is put into operation. If the measured open-circuit voltage deviates from the specification, there is a connection error. Also make sure the polarity is correct.

Insert the plug connectors correctly. Connectors may only be inserted in a dry condition. Also make sure that gap-free connection is possible. In addition, the requirements of the inverters that are used must be observed.

If the modules are connected in parallel, appropriate overcurrent protection must be used. Fuses for DC voltage must be used for this purpose, which prevent a reverse current greater than 15 A.

Also observe the connection conditions and the design guidelines of the inverter manufacturers.

Example 2 - Direct screw connection

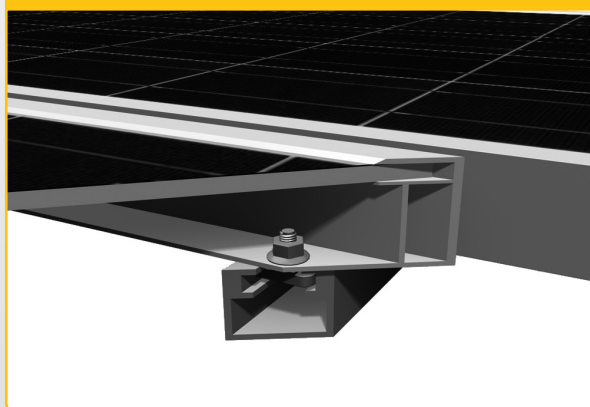

Check the plug-in connection of the supplied modules before installation and if the completed strings are working correctly after completion of each string. This is performed by means of a voltage test. Explicit attention must be paid here to the snap-in between the plastic cable sheath and the aluminium cable sheath. The snap-in should be audible. If the string and/or the plug-in connection does not appear to work correctly, contact Solar Fabrik GmbH immediately.

Proper cabling

Under no circumstances open the junction box. The modules are already equipped ex works with the necessary cables and connectors.

Ensuring correct wiring

The integrated connecting cables are UV-resistant. The connecting cables have a conductor cross-section of 4 mm². For connection, the connecting cables have pre-assembled connectors that are protected against reverse polarity.

Using suitable materials only

The system may only be wired with special solar cables in accordance with DIN EN 50618 class 5 and suitable plugs.

It is of utmost importance that all materials used are in perfect electrical and mechanical condition. Only use single-core cables and select the appropriate conductor cross-section to minimise the voltage drop.

Only use suitable cables with a minimum cross section of 4 mm² for the further connection of the modules. For longer distances, the cable cross section must be adjusted accordingly. For cable laying, also follow the specified requirements in accordance with DIN VDE 0298-3.

Solar module mounting instructions

Mono S4 ▪ Mono S3 ▪ Mono S2 ▪ M series ▪ P series



MOUNTING-VARIANTS STANDARD MODULES																																			
LOAD CAPACITY 2400 N/m ²																																			
MODULE FRAME SELECTIVELY STORED		MODULE FRAME STORED FLAT/AERODYNAMICALLY																																	
	<table border="1"> <thead> <tr> <th>Solar module</th> <th>Mounting</th> </tr> </thead> <tbody> <tr> <td>P series</td> <td>clamped 4x</td> </tr> <tr> <td>M series</td> <td>A = 200-300 mm</td> </tr> <tr> <td>Mono S2</td> <td></td> </tr> <tr> <td>M series [HC]</td> <td></td> </tr> <tr> <td>Mono S2 [HC]</td> <td>A = 200-300 mm</td> </tr> <tr> <td>Mono S3 [HC]</td> <td></td> </tr> <tr> <td>Mono S4 [HC][108 cells]</td> <td>A = 250-350 mm</td> </tr> </tbody> </table>	Solar module	Mounting	P series	clamped 4x	M series	A = 200-300 mm	Mono S2		M series [HC]		Mono S2 [HC]	A = 200-300 mm	Mono S3 [HC]		Mono S4 [HC][108 cells]	A = 250-350 mm		<table border="1"> <thead> <tr> <th>Solar module</th> <th>Mounting</th> </tr> </thead> <tbody> <tr> <td>P series</td> <td>clamped 4x</td> </tr> <tr> <td>M series</td> <td>A = 200-300 mm</td> </tr> <tr> <td>Mono S2</td> <td></td> </tr> <tr> <td>M series [HC]</td> <td></td> </tr> <tr> <td>Mono S2 [HC]</td> <td>A = 200-300 mm</td> </tr> <tr> <td>Mono S3 [HC]</td> <td></td> </tr> <tr> <td>Mono S4 [HC][108 cells]</td> <td>A = 250-350 mm</td> </tr> </tbody> </table>	Solar module	Mounting	P series	clamped 4x	M series	A = 200-300 mm	Mono S2		M series [HC]		Mono S2 [HC]	A = 200-300 mm	Mono S3 [HC]		Mono S4 [HC][108 cells]	A = 250-350 mm
Solar module	Mounting																																		
P series	clamped 4x																																		
M series	A = 200-300 mm																																		
Mono S2																																			
M series [HC]																																			
Mono S2 [HC]	A = 200-300 mm																																		
Mono S3 [HC]																																			
Mono S4 [HC][108 cells]	A = 250-350 mm																																		
Solar module	Mounting																																		
P series	clamped 4x																																		
M series	A = 200-300 mm																																		
Mono S2																																			
M series [HC]																																			
Mono S2 [HC]	A = 200-300 mm																																		
Mono S3 [HC]																																			
Mono S4 [HC][108 cells]	A = 250-350 mm																																		
	<table border="1"> <thead> <tr> <th>Solar module</th> <th>Mounting</th> </tr> </thead> <tbody> <tr> <td>P series</td> <td>clamped 4x</td> </tr> <tr> <td>M series</td> <td>B = 0-250 mm</td> </tr> <tr> <td>Mono S2</td> <td></td> </tr> <tr> <td>M series [HC]</td> <td></td> </tr> <tr> <td>Mono S2 [HC]</td> <td>B = 0-250 mm</td> </tr> <tr> <td>Mono S3 [HC]</td> <td></td> </tr> <tr> <td>Mono S4 [HC][108 cells]</td> <td></td> </tr> </tbody> </table>	Solar module	Mounting	P series	clamped 4x	M series	B = 0-250 mm	Mono S2		M series [HC]		Mono S2 [HC]	B = 0-250 mm	Mono S3 [HC]		Mono S4 [HC][108 cells]			<table border="1"> <thead> <tr> <th>Solar module</th> <th>Mounting</th> </tr> </thead> <tbody> <tr> <td>P series</td> <td>clamped 4x</td> </tr> <tr> <td>M series</td> <td>B = 0-250 mm</td> </tr> <tr> <td>Mono S2</td> <td></td> </tr> <tr> <td>M series [HC]</td> <td></td> </tr> <tr> <td>Mono S2 [HC]</td> <td>B = 0-250 mm</td> </tr> <tr> <td>Mono S3 [HC]</td> <td></td> </tr> <tr> <td>Mono S4 [HC][108 cells]</td> <td></td> </tr> </tbody> </table>	Solar module	Mounting	P series	clamped 4x	M series	B = 0-250 mm	Mono S2		M series [HC]		Mono S2 [HC]	B = 0-250 mm	Mono S3 [HC]		Mono S4 [HC][108 cells]	
Solar module	Mounting																																		
P series	clamped 4x																																		
M series	B = 0-250 mm																																		
Mono S2																																			
M series [HC]																																			
Mono S2 [HC]	B = 0-250 mm																																		
Mono S3 [HC]																																			
Mono S4 [HC][108 cells]																																			
Solar module	Mounting																																		
P series	clamped 4x																																		
M series	B = 0-250 mm																																		
Mono S2																																			
M series [HC]																																			
Mono S2 [HC]	B = 0-250 mm																																		
Mono S3 [HC]																																			
Mono S4 [HC][108 cells]																																			
LOAD CAPACITY 5400 N/m ²																																			
MODULE FRAME SELECTIVELY STORED		MODULE FRAME STORED FLAT/AERODYNAMICALLY																																	
	<table border="1"> <thead> <tr> <th>Solar module</th> <th>Mounting</th> </tr> </thead> <tbody> <tr> <td>P series</td> <td>clamped 6x</td> </tr> <tr> <td>M series</td> <td>B = 150-350 mm Z = vert. zentriert</td> </tr> <tr> <td>Mono S2</td> <td></td> </tr> <tr> <td>M series [HC]</td> <td></td> </tr> <tr> <td>Mono S2 [HC]</td> <td>B = 150-350 mm Z = vert. zentriert</td> </tr> <tr> <td>Mono S3 [HC]</td> <td></td> </tr> <tr> <td>Mono S4 [HC][108 cells]</td> <td></td> </tr> </tbody> </table>	Solar module	Mounting	P series	clamped 6x	M series	B = 150-350 mm Z = vert. zentriert	Mono S2		M series [HC]		Mono S2 [HC]	B = 150-350 mm Z = vert. zentriert	Mono S3 [HC]		Mono S4 [HC][108 cells]			<table border="1"> <thead> <tr> <th>Solar module</th> <th>Mounting</th> </tr> </thead> <tbody> <tr> <td>P series</td> <td>clamped 4x</td> </tr> <tr> <td>M series</td> <td>C = 250-450 mm</td> </tr> <tr> <td>Mono S2</td> <td></td> </tr> <tr> <td>M series [HC]</td> <td></td> </tr> <tr> <td>Mono S2 [HC]</td> <td>C = 250-450 mm</td> </tr> <tr> <td>Mono S3 [HC]</td> <td></td> </tr> <tr> <td>Mono S4 [HC][108 cells]</td> <td></td> </tr> </tbody> </table>	Solar module	Mounting	P series	clamped 4x	M series	C = 250-450 mm	Mono S2		M series [HC]		Mono S2 [HC]	C = 250-450 mm	Mono S3 [HC]		Mono S4 [HC][108 cells]	
Solar module	Mounting																																		
P series	clamped 6x																																		
M series	B = 150-350 mm Z = vert. zentriert																																		
Mono S2																																			
M series [HC]																																			
Mono S2 [HC]	B = 150-350 mm Z = vert. zentriert																																		
Mono S3 [HC]																																			
Mono S4 [HC][108 cells]																																			
Solar module	Mounting																																		
P series	clamped 4x																																		
M series	C = 250-450 mm																																		
Mono S2																																			
M series [HC]																																			
Mono S2 [HC]	C = 250-450 mm																																		
Mono S3 [HC]																																			
Mono S4 [HC][108 cells]																																			
	<table border="1"> <thead> <tr> <th>Solar module</th> <th>Mounting</th> </tr> </thead> <tbody> <tr> <td>P series</td> <td>clamped screwed D = 325mm</td> </tr> <tr> <td>M series</td> <td>C = 250-450 mm D = 325mm</td> </tr> <tr> <td>Mono S2</td> <td>D = 332mm</td> </tr> <tr> <td>M series [HC]</td> <td>D = 337mm</td> </tr> <tr> <td>Mono S2 [HC]</td> <td>C = 250-450 mm D = 242mm</td> </tr> <tr> <td>Mono S3 [HC]</td> <td>D = 382,5mm</td> </tr> <tr> <td>Mono S4 [HC][108 cells]</td> <td>D = 382,5mm</td> </tr> </tbody> </table>	Solar module	Mounting	P series	clamped screwed D = 325mm	M series	C = 250-450 mm D = 325mm	Mono S2	D = 332mm	M series [HC]	D = 337mm	Mono S2 [HC]	C = 250-450 mm D = 242mm	Mono S3 [HC]	D = 382,5mm	Mono S4 [HC][108 cells]	D = 382,5mm		<table border="1"> <thead> <tr> <th>Solar module</th> <th>Mounting</th> </tr> </thead> <tbody> <tr> <td>P series</td> <td>screwed 4x D = 325mm</td> </tr> <tr> <td>M series</td> <td>D = 325mm</td> </tr> <tr> <td>Mono S2</td> <td>D = 332mm</td> </tr> <tr> <td>M series [HC]</td> <td>D = 337mm</td> </tr> <tr> <td>Mono S2 [HC]</td> <td>D = 242mm</td> </tr> <tr> <td>Mono S3 [HC]</td> <td>D = 382,5mm</td> </tr> <tr> <td>Mono S4 [HC][108 cells]</td> <td>D = 382,5mm</td> </tr> </tbody> </table>	Solar module	Mounting	P series	screwed 4x D = 325mm	M series	D = 325mm	Mono S2	D = 332mm	M series [HC]	D = 337mm	Mono S2 [HC]	D = 242mm	Mono S3 [HC]	D = 382,5mm	Mono S4 [HC][108 cells]	D = 382,5mm
Solar module	Mounting																																		
P series	clamped screwed D = 325mm																																		
M series	C = 250-450 mm D = 325mm																																		
Mono S2	D = 332mm																																		
M series [HC]	D = 337mm																																		
Mono S2 [HC]	C = 250-450 mm D = 242mm																																		
Mono S3 [HC]	D = 382,5mm																																		
Mono S4 [HC][108 cells]	D = 382,5mm																																		
Solar module	Mounting																																		
P series	screwed 4x D = 325mm																																		
M series	D = 325mm																																		
Mono S2	D = 332mm																																		
M series [HC]	D = 337mm																																		
Mono S2 [HC]	D = 242mm																																		
Mono S3 [HC]	D = 382,5mm																																		
Mono S4 [HC][108 cells]	D = 382,5mm																																		

Solar module mounting instructions

Mono S4 ▪ Mono S3 ▪ Mono S2 ▪ M series ▪ P series



MOUNTING-VARIANTS | NON STANDARD MODULES

LOAD CAPACITY 2400 N/m²

MODULE FRAME SELECTIVELY STORED

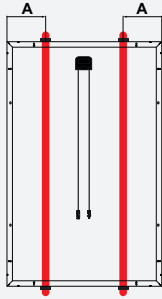

Solar module	Mounting
	clamped 4x
P series [72 cells]	A = 200-300 mm
M series [72 cells]	
Mono S2 [72 cells]	
Mono S2 [HC][144 cells]	
Mono S3 [HC][144 cells]	

MODULE FRAME STORED FLAT/AERODYNAMICALLY

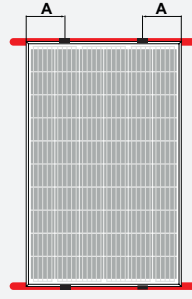

Solar module	Mounting
	clamped 4x
P series [72 cells]	A = 200-300 mm
M series [72 cells]	
Mono S2 [72 cells]	
Mono S2 [HC][144 cells]	
Mono S3 [HC][144 cells]	

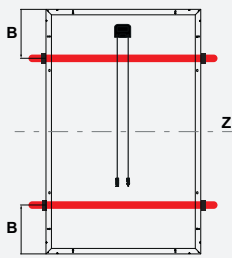

Solar module	Mounting
	clamped 4x
P series [72 cells]	B = 200-240 mm or B = 320-360 mm
M series [72 cells]	
Mono S2 [72 cells]	
Mono S2 [HC][144 cells]	
Mono S3 [HC][144 cells]	

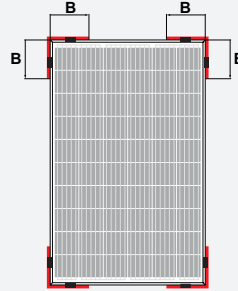

Solar module	Mounting
	clamped 4x
P series [72 cells]	B = 0-250 mm
M series [72 cells]	
Mono S2 [72 cells]	
Mono S2 [HC][144 cells]	
Mono S3 [HC][144 cells]	

LOAD CAPACITY 5400 N/m²

MODULE FRAME SELECTIVELY STORED

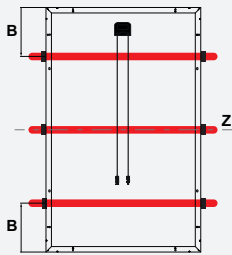

Solar module	Mounting
	clamped 6x
P series [72 cells]	B = 200-240mm or B = 320-360mm Z = vert. zentriert
M series [72 cells]	
Mono S2 [72 cells]	
Mono S2 [HC][144 cells]	
Mono S3 [HC][144 cells]	

MODULE FRAME STORED FLAT/AERODYNAMICALLY

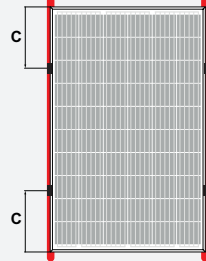

Solar module	Mounting
	clamped 4x
P series [72 cells]	C = 240-320mm
M series [72 cells]	
Mono S2 [72 cells]	
Mono S2 [HC][144 cells]	
Mono S3 [HC][144 cells]	

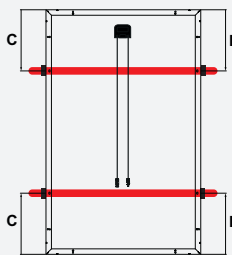

Solar module	Mounting
	clamped screwed
P series [72 cells]	D = 264mm
M series [72 cells]	D = 264mm
Mono S2 [72 cells]	C = 240-320mm D = 270mm
Mono S2 [HC][144 cells]	D = 284mm
Mono S3 [HC][144 cells]	D = 327mm

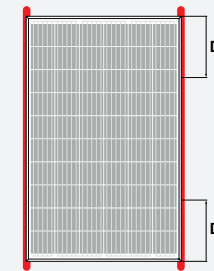

Solar module	Mounting
	screwed 4x
P series [72 cells]	D = 264mm
M series [72 cells]	D = 264mm
Mono S2 [72 cells]	D = 270mm
Mono S2 [HC][144 cells]	D = 284mm
Mono S3 [HC][144 cells]	D = 327mm

Solar module mounting instructions

Mono S4 ▪ Mono S3 ▪ Mono S2 ▪ M series ▪ P series

Protecting the cables from damaging environmental influences

Only use UV-resistant cable ties to fix the cables to the mounting system. Protect exposed cables from possible damage, e.g. by laying them in plastic pipes. Avoid direct sunlight.

Under normal conditions, a PV module can deliver a higher current and/or voltage than specified in the standardised test conditions under expected conditions. To determine the rated voltage values of components, rated current values of conductors, sizes of fuses and dimensioning of controllers connected to the output of PV modules.

The values of I_{sc} and U_{oc} edges. Furthermore, avoid soiling indicated on the module should therefore be multiplied by a factor of 1.25.

Ensuring the plug connectors are correctly installed

To ensure that connectors are used correctly, it is permitted to disconnect the module cable shortly before the module connector and to install an alternative connector approved in writing by Solar Fabrik GmbH.

The connectors marketed by Solar Fabrik GmbH are approved for mounting. Further informations are available on request. Please contact your Solar Fabrik GmbH sales representative.

The mounting of the connector on the module must be carried out according to the mounting instructions enclosed with the connector. The complete reassembly of the plug connector may only be carried out at ground level. It is also important to ensure that the module is not connected to the generator field during operation.

The photoactive front side of the module should be covered as far as possible or face the ground during all work steps to keep the voltage low.

If all installation instructions are observed and the installation is carried out by a technical specialist, the product guarantee of the modules remains in full force.

Maintenance and cleaning

Usually rainfall ensures that the modules are cleaned automatically. With sufficient inclination (greater than 15°), it is therefore generally not necessary to specially clean the modules. In the event of heavy soiling, we recommend cleaning with plenty of water, but without cleaning agents.

Wear clean, non-slip gloves during all transport and installation work to prevent injury from cuts on module edges. Furthermore, avoid soiling the solar glass with fingerprints, as they can damage the special coating of the glass.

In case of heavy soiling, we recommend cleaning with plenty of water with low levels of lime. The pH value of the water should be between 6.0 and 7.5. Please do not use any nozzle attachment and only an appropriate water pressure and temperature. The use of cleaning agents and scratching cleaning equipment would damage the special anti-reflective coating and invalidate the product and performance guarantee.

Never scrape off or rub off impurities when the module is dry. Damage to the highly efficient antireflective surface can lead to optical changes of the module surface as well as to power losses.

The use of automatic cleaning machines for solar systems is at your own risk and is not approved by Solar Fabrik GmbH.

Solar module mounting instructions

Mono S4 ▪ Mono S3 ▪ Mono S2 ▪ M series ▪ P series

Inspect the system regularly and check the system for:

- Secure attachment and that all fastenings are free of
- corrosion
- Safe connection, cleanliness, integrity and that all cable connections are freed from corrosion
- Contact resistances of the potential equalisation

Instructions for disassembly → Shut down.

- Disconnect the inverter(s) on the AC side from the mains supply so that the photovoltaic system is without load.
- Disconnect the photovoltaic system from the inverter at the
- DC-side disconnection point.
- Make sure that voltage is no longer applied to the system.
- The photovoltaic system can now be disassembled. Please observe the safety instructions.

Disposal of the modules

Disposal and recycling of solar modules are regulated by the Electrical and Electronic Equipment Act (ElektroG), which transposes the WEEE Directive into German law.

Please also observe country-specific regulations. It is possible that notification is required in the respective country.

Note on liability and status of the instructions

If there are deviations from the instructions contained in this user information, Solar-Fabrik GmbH does not accept any liability for the use and functionality of the modules.

Please note that failure to comply will void any claim on corresponding warranty services.

Since it is not possible for Solar-Fabrik GmbH to check or monitor compliance with the above-mentioned safety instructions as well as the conditions and methods of installation, operation, use and maintenance of the modules, Solar-Fabrik GmbH also accepts no liability for damage resulting from improper use, incorrect installation, operation, use or maintenance.

The text and illustrations in these mounting instructions correspond to the technical status at the time of printing.

Subject to change without notice.

Solar module mounting instructions

Mono S4 ▪ Mono S3 ▪ Mono S2 ▪ M series ▪ P series



4. Notes:



Solar modules



Solar Fabrik GmbH

Hermann-Niggemann-Str. 7
63846 Laufach
Germany

Phone: +49 (0) 6093 20770-0
Fax: +49 (0) 6093 20770-99

E-Mail: info@solar-fabrik.de
Internet: www.solar-fabrik.de