

INSTALLATION MANUAL

Jolywood N-type Mono-crystalline Double Glass Module
M6 Double-glass module (HD120N/P & HD144N/P)

Contents

1.0	Introduction	03
1.1	Disclaimer	03
1.2	Limitation of Liability	03
2.0	Safety Precautions	03
2.1	Warning	03
2.2	General Safety	03
2.3	Operation instruction	04
3.0	Unload, Transportation and Storage	04
3.1	Marks on Outer Packaging	05
3.2	Unloading Instructions	06
3.3	Secondary Transportation and Precautions	06
3.4	Storage	06
4.0	Unpacking Instruction	07
4.1	Unpacking Safety Instruction	07
4.2	Unpacking Steps	07
5.0	Installation	08
5.2.1	Installation Safety	09
5.2.2	Mechanical installation and precautions	09
5.2.3	Framed Bifacial Double-Glass Modules (installation with clamps)	11
5.2.4	Framed Bifacial Double-Glass Modules (installation with bolts)	13
5.2.5	Grounding	13
5.2.6	Electrical installation	14
5.2.7	Wiring	15
5.2.7.1	Fuse	15
6.0	Maintenance for PV Modules	15
6.1	Module Visual Inspection and Replacement	15
6.2	Connector and Cable Inspection	16
6.3	Cleaning	17
6.3.1	Water quality requirements	17
6.3.2	Module Inspection after Cleaning	17
6.3.3	Troubleshooting	18
7.0	Technical Issues or Claims	18

1.0 Introduction

This manual contains relevant information about the installation methods and safe operation of photovoltaic modules (hereinafter referred to as "modules") of Jolywood Solar Technology Co., Ltd (hereinafter referred to as "Jolywood"). Now the standard modules JW-HD120 series(module size 1756*1039*30mm、1773*1046*30mm) and JW-HD144(module size 2095*1039*30mm) series are included. the manual would be updated when new module introduced in the future. Failure to follow these safety guidelines may result in personal injury or death or property damage.

The installer must read and understand this guide before installation. Any question, please contact our customer service department or our local representative for more detailed information. The installer must follow all safety precautions in this guide, local requirements, regulations of laws or authorized agencies requirements. Before installing a solar photovoltaic system, the installer should be familiar with its mechanical and electrical requirements. The installer required relevant professional knowledge, and the system must be installed and maintained by qualified person with professional knowledge.

Please store this guide in a safe place for future reference (maintenance), which would also be useful when selling or disposing of the modules.

The modules of Jolywood have passed the tests of IEC standards in certification agencies. Please rest assured that you can use them under the premise of complying with the requirements of this installation manual.

The module installer must inform the end customer (or consumer) of the above matters accordingly.

1.1 Declaration

Jolywood reserves the right to change this installation manual without prior notice. Jolywood does not make any guarantee for any express or implied information contained in this manual. If customer fails to follow the requirements listed in this manual during the installation of the modules, the limited product warranty provided would be invalidated.

1.2 Limitation of Liability

For any of the following injuries or losses, including but not limited to bodily injury and property damage caused by module operation, system installation errors, and failure to follow the instructions of this manual, Jolywood is not responsible for that.

2 Safety precautions

2.1 Warning

Before installing, wiring, operating or maintaining modules, you should read and understand all safety rules. Modules will generate electricity when exposed under a light source environment. The generate electricity from array of multiple modules would cause fatal electric shock or burns. Person without authorization and relevant training should not touch modules and wiring terminals.

2.2 General Safety

2.2.1

It is strictly forbidden to use modules with broken glass. Damaged modules must not be repaired. Contact with the surface of the modules may cause electric shock. Do not disassemble the module or remove any part of the module. Do not artificially gather sunlight on these solar modules.

2.2.2

The operator of the system requires relevant professional knowledge, and the system must be installed and maintained by qualified person with professional knowledge. Persons without authorization and relevant training should not touch modules and approach the installation area or module storage area.

2.2.3

Do not connect the positive terminal of a single module to the positive terminal of another module. Please make sure that the polarity of each module or module string is not opposite to other modules or module strings. Please make sure that there are no gaps between the insulating washers of the joint. If there are gaps between the insulating washers, it may cause the risk of fire or electric shock.

2.2.4

According to the requirements of the National Electrical Code, the maximum system voltage should not exceed 1500V.

2.2.5

Do not install module when the module is wet or windy.

2.3 operation instruction

2.3.1

In order to avoid damage module, please do not scratch or hit module, and do not use paint or adhesive on the front or back side of module. In order to ensure insulation performance of modules from be damaged, please avoid scratching, cutting the cables and connectors or exposed under the sun for a long time. Do not drop module or drop other things onto the module surface. Do not place any heavy or sharp objects on the module surface.

2.3.2

Please do not use water to extinguish fire when the power is on.

2.3.3

Only work in a dry environment, and only use dry tools. Do not work in a humid environment without wearing any protective measures. When exposed under the sun, no matter whether module is connected or not, please do not directly touch junction box, connector, cable or other charged objects of module without any protection.

2.3.4

It is forbidden to climb, step on, stand, walk or jump directly on the package or module.

3.0

Unload, Transportation and Storage

Preventive measures and general safety rules:

Modules should be stored in the original box before installation. Please protect the package from be damaged. Transport or unpack modules

with recommended shipping method and unpacking procedure. In order to avoid damage, scratch or strike module. Do not apply pressure directly on the module during transportation. Improper transportation or installation also may damage module, which is excluded from the warranty. Do not stand, climb, walk or jump on unpacked pallets of modules.

Always work under a dry environment, ensure that all modules and electrical contacts are clean and dry before installation. If it is necessary to store the modules outdoors for a certain period of time, always cover module and ensure that the glass surface is facing down on a soft surface, preventing water from entering inside of the module, preventing connectors from be damaged.

Unpacking must be operated by two or more people at the same time. Do not lift module by grasping module terminal box or lead wires. Use both hands to carry the module and do not stack modules. Do not place modules in an environment without reliable support or unfixed. Do not place any heavy objects or sharp objects on modules.

3.1 Marks on Outer Packaging



3.1.1 Prohibit discarding modules randomly, special recycling is needed



3.1.2 Protect modules from rain or moisture



3.1.3 Modules in carton are fragile, shall be handled with care

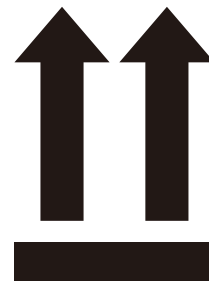

3.1.4 The package should be vertically up during transportation

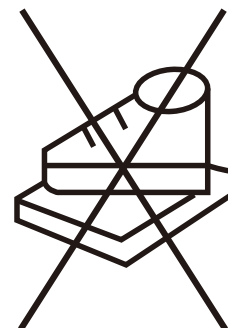

3.1.5 Do not step on or stand above package or module



3.1.6 Stack no more than 2 layers

3.2 Unloading Instructions

3.2.1

When unloading modules from vehicle, less than 2 lots package could be lifted each time with a reasonable fixture. Before lifting, ensure that the trays and cartons undamaged, the hoisting ropes are durable. When the hoisting is near the ground, two men put carton gently on a relative flat position. Using a forklift to remove modules from the truck, unloaded modules should be placed on a level surface. The depth of forklift forks into the pallet shall not be less than 3/4 of the pallet length.

3.2.2

When modules is temporarily stored in a project site, modules should be placed in a dry and ventilated place. Do not stack modules at a project site. Cover modules with a tarpaulin, the tarpaulin should be fixed by a curtain or mesh belt to protect modules from moisture and rain.

3.3 Secondary Transportation and Precautions

3.3.1

If the module would be transported for a too long distance or stored for a long period, it is forbidden to remove the original package. Modules

packaged with original package could be transported by land, sea or air. During transportation, fixing the package to the transport platform to ensure it would not be tumbled. Taking land transportation as an example. When transported with truck, stacking up should be less than two layers, it is forbidden to cut the packaging belts of packages. There shall be no gap between pallets or between pallets and truck supports. If there is a gap, it must be filled with fillers (inflatable bags, etc.) to prevent modules from tilting and shaking during transportation.

3.3.2

It is forbidden to remove the original package when modules transported at a project site. One pallet transported each time is required. During transportation, fixing package to the transport platform to ensure that the package would not be tumbled. Do not use tricycle to transport modules. Do not handle modules with rope during transportation, and it is forbidden to carry or drag modules through the wires or junction box of the modules.

3.4 Storage

Please store the modules in a dry and ventilated environment and place the modules on a relatively flat ground to avoid package damage or dumping due to ground deformation or collapse. Storage requirements: humidity <85%, temperature range -40 °C -50 °C.

If the modules need long-distance transportation or long-term storage, do not remove the original packaging, and keep the wrapping film and packaging carton intact.

For long-term storage of modules, it is recommended to store them in a standard warehouse for regular patrol inspection. In case of abnormal inclination, please reinforce them in time under the condition of ensuring personal safety.

The shelves in the warehouse shall have sufficient bearing capacity and storage space, and regular patrol inspection shall be conducted to ensure the safe storage of goods. If the modules need to be stored in the project site, it is forbidden to select the soft and collapsible ground. Instead, the hard ground or the ground with high terrain should be selected and leveled to ensure that the modules will not collapse or tilt during long-term storage.

In rainy weather, please use a rain cloth to completely cover the modules and pallets, and take rain and moisture-proof measures for the pallets and cartons. In case of sunshine or wind, remove the rain cloth to dry the outer packaging as soon as possible, so as to avoid collapse due to moisture deformation. It is forbidden to soak the tray in the rain to cause mildew and decay. The ground drainage measures should be taken first to prevent the ground from being soft and sinking due to a large amount of water on the ground after the rain. Unauthorized access to the module storage area is prohibited.

4.0 Unpacking instruction

4.1 Unpacking safety instruction

4.1.1

When modules unpacked outdoors, it is forbidden to work under rain, as carton would become soft and be broken. Modules inside of it would come out, damage or bruises may be caused to module. During windy days, special attention should be paid for safety, it is recommended not to transport

modules, and the unpacked modules should be properly fixed.

4.1.2

The ground needs to be flat enough to ensure package could be placed horizontally and stably. Supportive tool should be used when disassembling the carton to prevent the modules from falling down.

4.1.3

Wear protective gloves during unpacking to avoid injury and fingerprints on the glass surface.

4.1.4

Module information could be queried from outer package, please read it carefully before unpacking.

4.1.5

Each module should be lifted by two man. Do not lift module by grasping the module terminal box or lead wires. Use both hands to carry module, do not stack modules during lifting.

4.1.6

The unpacked modules must all be installed, should not be stored at the project site. It is forbidden to stack in the project site for a long time, and the number of temporarily stacked modules shall not exceed 16.

4.2 Unpacking steps

4.2.1

Before unpacking, please check the product name and serial number on an A4 paper on the surface of the package, unpacking method should not be randomly changed.

4.2.2

When unpacking, cut all vertical packing belts with a blade or scissors, first cut the long side packing belt, secondly cut the short side packing belt. Remove the upper cover of the carton and take out two or three upper lifting brackets.

4.2.3

When removing modules from package, two people stand must stand on each side of the box while lifting the module, one hand grasping the corner of the module, the other hand grasping the short side of the module. When unpacking on a horizontal floor, remove modules from one side to the other side of package, and then carry them. If unpacking on a non-horizontal floor, use a supportive tool to ensure package placed vertically.

4.2.4

Modules removed out of package are prohibited from leaning against a without reliable support or an unfixed object.

5.0 Installation

Double glass modules produced by Jolywood could work for more than 30 years under proper conditions. Modules with an expired life should be reasonably disposed in accordance with local laws and regulations. Besides requirement of IEC certification, the product has been tested to verify its resistance to ammonia, which may be present near the cowshed, whether it could work in a wet (coastal) areas, areas where sandstorms occur frequently are also tested.

5.1 Installation Safety

5.1.1

The modules produced by Jolywood could installed landscape or portrait, the influence of shading effect caused by dust could be minimized when installed landscape.

5.1.2

Do not remove module package before installation.

5.1.3

When installing modules, only work in a dry environment with dry tools. Do not work in a humid environment without wearing any protective measures. Do not install modules under any rainy, snowy or windy conditions. Keep the connectors dry and clean when installing modules to avoid the risk of electric shock. If the terminal of the module is wet, no work could be done, otherwise electric shock may be caused. Modules should be installed immediately after unpacked.

5.1.4

Do not wear metal rings, wristwatches, earrings, nose rings, lip rings, or other metal materials when installing or repairing PV systems.

5.1.5

Use opaque materials to cover the module completely during installation. Do not open the electrical connection or pull out the connector while the circuit is under load. Do not touch the modules during installation unless necessary. Glass surfaces and brackets may have high temperature, which might lead to the risk of hazards of burns and electric shock.

5.1.6

Do not damage the back glass of module when modules mounted on the bracket. If modules need to be replaced, do not damage the surrounding modules or mounting structure.

5.1.7

When installing modules, do not work alone, and keep working with a team of two or more men.

5.1.8

After modules are installed, the cables should be fixed or tied to avoid exposed under direct sunlight after installation, which would prevent cable from aging. Low-hanging cables can cause various problems, such as electric leakage and fire.

5.1.9

The application level of module produced by Jolywood is Class A. modules with different color should be avoided from installed in the same array or roof.

5.2 Installation method

5.2.1 Mechanical installation and precautions

Modules could be mounted with clamps or bolts. Modules Installation must be carried out according to the following examples and recommendations. If the installation method is different from below methods, please consult Jolywood local technical support or after-sales, to obtain the consent of Jolywood, otherwise when the modules is damaged, the limit warranty would be invalid.

The mechanical load of the module (including

snow and wind loads) depends on the way of module installed. The mechanical load should be calculated by the professional system designer based on actual conditions and environmental. Moreover, it does not withstand the excessive force generated by the thermal expansion of the support structure. The drain hole should not be blocked under any conditions during installation or use.

5.2.2 Framed Bifacial Double-Glass Modules (installation with clamps)

Clamp:

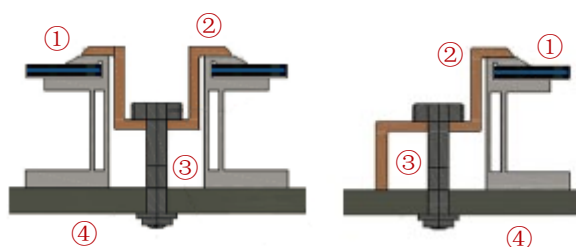

①frame ②clip ③ M8 bolt ④mounting rail

JW-HD120N/P

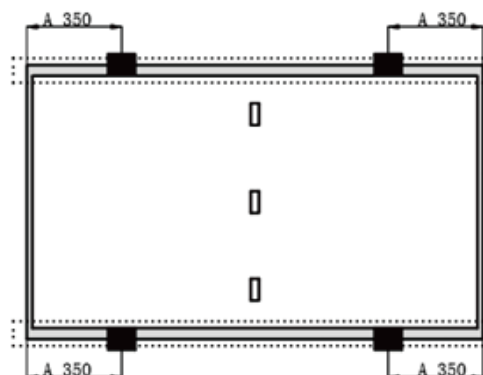

Mounted with 4 clamps along long frame. C-shaped steel parallel to the long frame. Edge Clamp: width=40-50mm, height=30mm. A=350±30mm
 maximum test load: front ≤2400Pa
 back ≤2400Pa

JW-HD120N/P

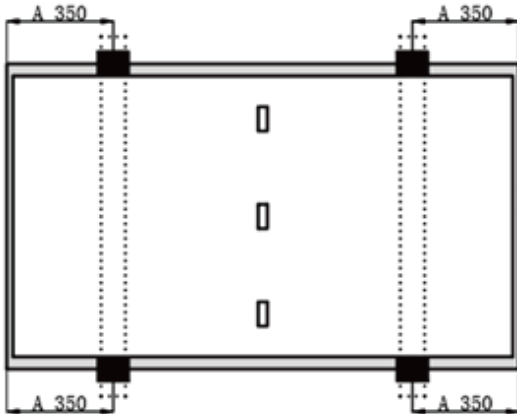

Mounted with 4 clamps along long frame.
 C-shaped steel perpendicular to the long frame
 Edge Clamp: width=40-50mm,
 height=30mm. A=350±30mm
 maximum test load: front ≤5400Pa
 back ≤2400Pa

JW-HD120N/P

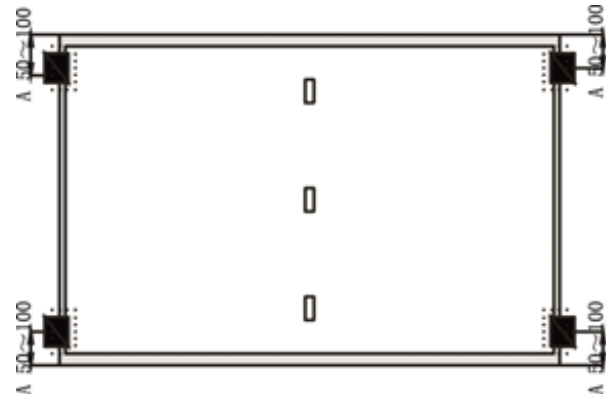

Mounted with 4 clamps along short frame.
 Edge Clamp: width=40-50mm, height=30mm.
 A=50~100mm
 maximum test load: front ≤1200Pa
 back ≤1200Pa

JW-HD120N/P

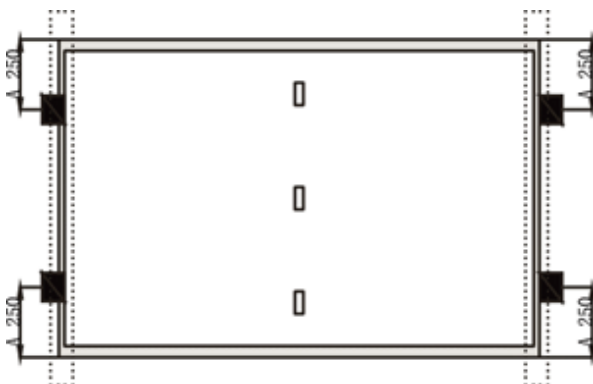

Mounted with 4 clamps along short frame.
 C-shaped steel parallel to the short frame
 Edge Clamp: width=40-50mm,
 height=30mm. A=250±30mm
 maximum test load: front ≤1200Pa
 back ≤1200Pa

JW-HD120N/P

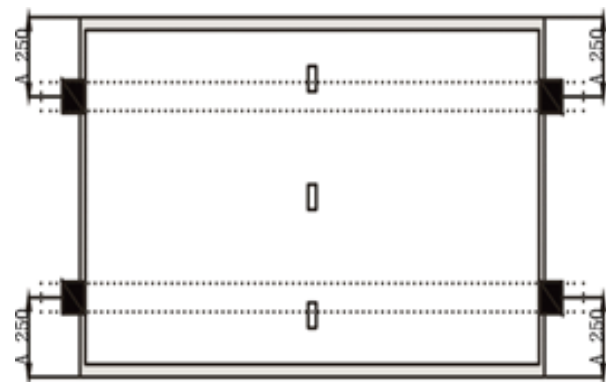

Mounted with 4 clamps along short frame.
 C-shaped steel parallel to the long frame.
 Edge Clamp: width=40-50mm,
 height=30mm. A=250±30mm
 maximum test load: front ≤4800Pa
 back ≤1200Pa

JW-HD120N/P

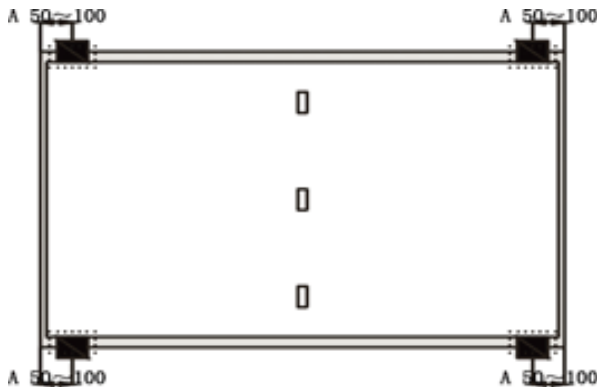

Mounted with 4 clamps along long frame.
 Edge Clamp: width=40-50mm, height=30mm.
 A=50~100mm
 maximum test load: front $\leq 1800\text{Pa}$
 back $\leq 1800\text{Pa}$

JW-HD144N/P

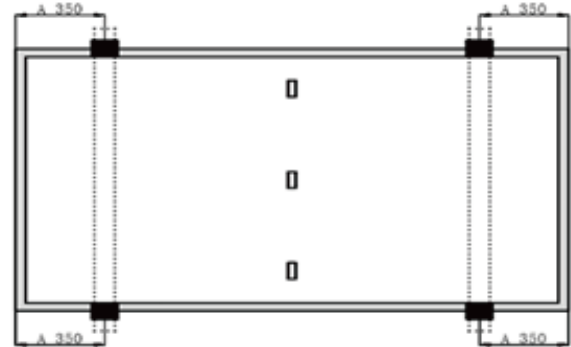

Mounted with 4 clamps along long frame.
 C-shaped steel perpendicular to the long frame
 Clamp: width=40-50mm, height=30mm.
 A=350±30mm
 maximum test load: front $\leq 5400\text{Pa}$
 back $\leq 2400\text{Pa}$

JW-HD144N/P

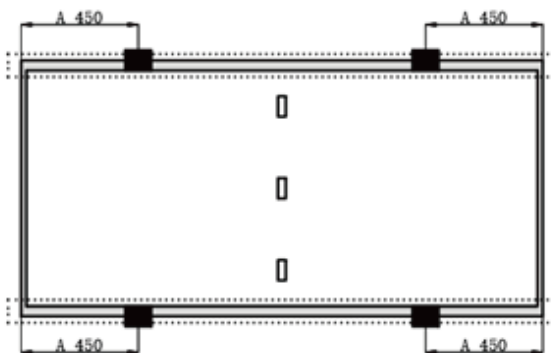

Mounted with 4 clamps along long frame.
 C-shaped steel parallel to the long frame.
 Edge Clamp: width=40-50mm,
 height=30mm. A=450±30mm
 maximum test load: front $\leq 2400\text{Pa}$
 back $\leq 2400\text{Pa}$

5.2.3 Framed Bifacial Double-Glass modules (installation with bolts)

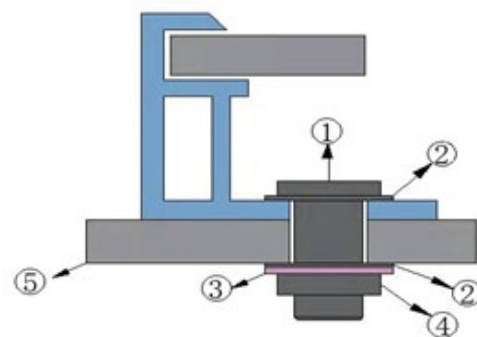

- ① M8 screw ② Flat washer ③ Spring washer
- ④ Nut ⑤ Mounting Rail

5.2.3.1

The mounting holes on the back of the module frame are installed on the support structure with

stainless steel bolts(the screw faces the frame mounting holes)

5.2.3.2

The modules are fastened at 8 points according to load requirements or installation requirements(Four points on the long side).

5.2.3.3

The tensile strength of M8*16 stainless steel outer hexagonal bolts, nuts, bolts and nuts should not be less than 450MPa, and the recommended torque is 16 Newton•m.

5.2.3.4

The outer flat washer needs to use M8 (A2-70), a stainless steel (SUS304) flat washer with an outer diameter of 20±2 mm and a thickness of 1.1-1.2 mm; the corresponding stainless steel spring washer thickness is 2.0±0.2mm.

Bolt installation method:

JW-HD120N/P

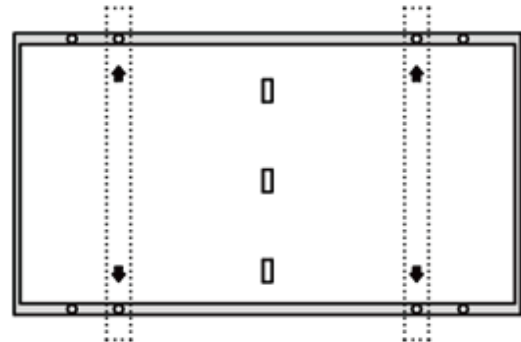

The long frame uses the inner four holes (990mm) for bolt installation
 Mounting bracket/C-shaped steel perpendicular to the long frame
 maximum test load: front ≤5400Pa
 back ≤2400Pa

JW-HD120N/P

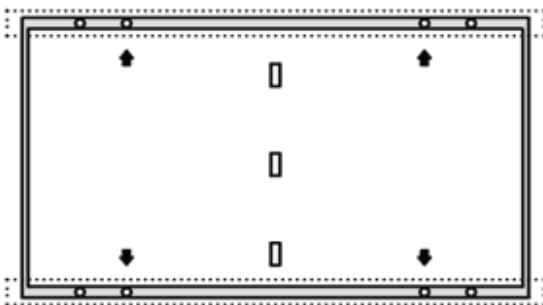

The long frame uses the inner four holes (990mm) for bolt installation
 Mounting rail/C-shaped steel parallel to the long side
 maximum test load: front ≤2400Pa
 back ≤2400Pa

JW-HD144N/P

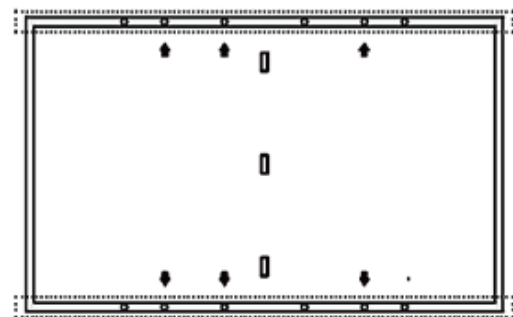

The long frame uses six inner holes for bolt installation
 Mounting rail/C-shaped steel parallel to the long side
 maximum test load: front ≤2400Pa
 back ≤2400Pa

JW-HD144N/P

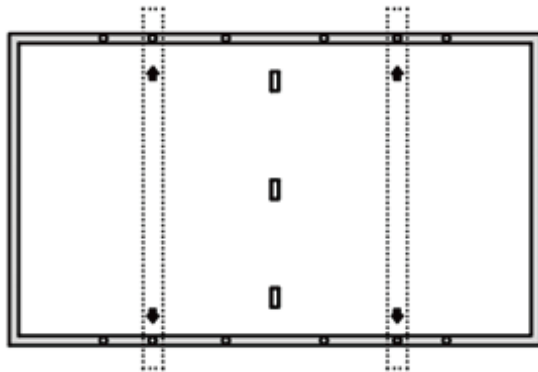

Use inner four holes for bolt installation
 C-shaped steel perpendicular to the long frame
 maximum test load: front $\leq 5400\text{Pa}$
 back $\leq 2400\text{Pa}$

JW-HD144N/P

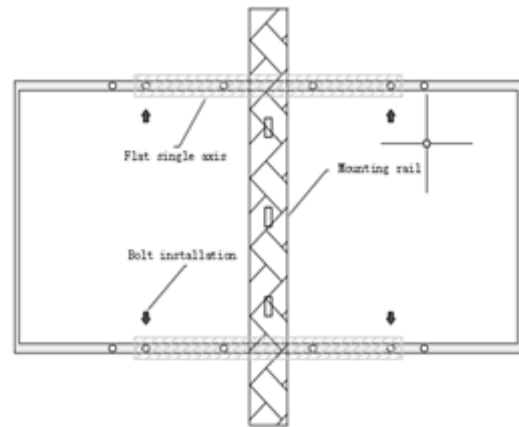

The long frame uses the inner four holes (1300mm) for bolt installation
 maximum test load: front $\leq 2400\text{Pa}$
 back $\leq 2400\text{Pa}$

5.2.4 Installation of full frame double glass modules (Installation with flat single axis tracker)

JW-HD144N/P modules can also be installed with flat single axis tracker. The specific installation methods are as follows:

JW-HD144N/P

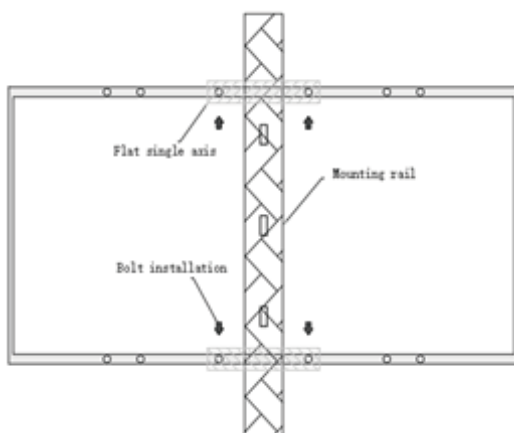

The long frame uses the inner four holes (400mm) for bolt installation
 maximum test load: front $\leq 1600\text{Pa}$
 back $\leq 1600\text{Pa}$

5.2.5 Grounding

5.2.5.1

All module frames and brackets must be properly grounded in accordance with the appropriate National Electrical Code. The grounding conductor or grounding wire could be made with copper, copper alloy or other material, which should also be in accordance with the requirements of corresponding National Electrical Code. The grounding conductor must be connected to the ground through a suitable grounding methods.

5.2.5.2

Module could be grounded with a grounding equipment listed by a third party. The equipment must be installed in accordance with the instructions given by the grounded equipment manufacturer.

5.2.5.3

Please visit <http://www.jolywood.cn/> to view the “Product Catalog” link for detailed grounding holes locations and dimensions.

5.2.5.4

The electrical contact is formed by penetrating the anodized coating of the aluminum frame and tightening the ground screw (together with the star washer) to an appropriate torque of 3~7N.m. A properly sized ground wire (4-16mm² copper core wire) should be selected and mounted under the connecting bolt.

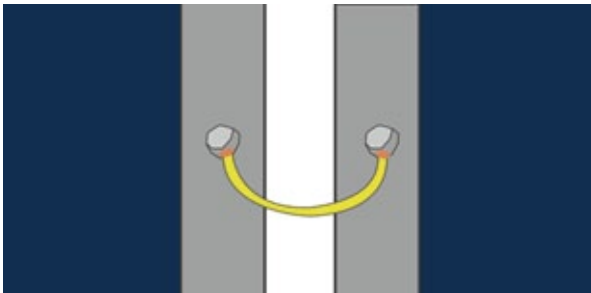

Place the toothed washers, washers, and grounding wires in turn, and screw the screws into the grounding holes to connect the two adjacent modules.

5.2.6 Electrical Installation

All wiring should be performed by a qualified and trained person in accordance with local regulations and procedures. Modules could be connected in series to increase the operating voltage by inserting the positive plug of one module into the negative plug of another module.

Always ensure that the contact points are corrosion-resistant, clean, and dry before wiring modules. If the polarities of modules connected

wrong, may lead to irreparable damage. Before modules connected in parallel, please check the voltage and polarity of each module array. If the polarity of products is opposite or Voltage difference greater than 10V founded after measurement, please check the configuration of module array before its access to power grids.

All cables and connectors used to connect the DC system must have similar (or higher) level. It is suggested that all cables should run in proper cable ducts and should be located away from the water-prone area.

Each module has two standard 90°C shading output cables with a plug-and-play connector on each terminal. Jolywood modules are equipped with a DC copper cable with a cross-sectional area of 4mm², system voltage 1500V DC, insulation layer maximum work temperature up to 90°C, also UV-resistant. All cables used to connect the DC system must have similar or high level. It is required that all wiring and electrical connections should be comply with the appropriate National Electrical Code.

The voltage of modules shall not be higher than the maximum voltage borne by the system, and factors such as the lowest expected temperature shall be considered. It is recommended to calculate according to the following formula:

$$\text{Maximum system voltage} \geq N \times V_{oc} \times [1 + (T_{cvoc} \times (T_{min} - 25))]$$

Of which:

N represents the number of modules;

V_{oc} represents the open circuit voltage of the component;

T_{cvoc} represents the temperature coefficient of

the component open circuit voltage;
 T_{min} represents the minimum ambient temperature;

5.2.7 Wiring

In order to ensure PV system could operation smoothly, when connecting modules or connecting loads (such as inverters batteries, etc.), ensure that the polarity of the cables is properly connected (Figure 1 and Figure 2). If modules are not connected properly, the bypass diode may be damaged. Modules could be connected in series to increase voltage. Connecting modules in series by inserting the positive terminal of one module into the negative terminal of the next module. Figure 1 shows the serial connection of modules. Modules could be connected in parallel to increase current (shown in Figure 2). Connecting modules in series in Parallel by inserting the positive terminal of one module into the negative terminal of the next module. The number of modules connected in series or in parallel needs to be reasonably designed according to the system configuration. All instructions above must be followed to meet the Jolywood Warranty valid conditions.

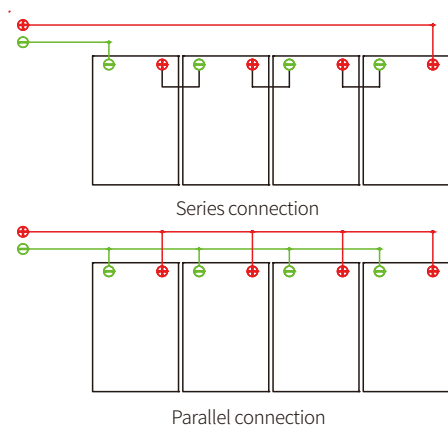
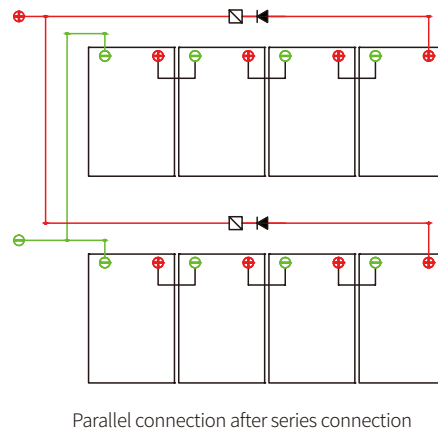

Figure 1



Parallel connection after series connection

Figure 2

5.2.7.1 Fuse

The fuse should be connected to each non-grounded pole of the array (in other words, if system is not grounded, the fuse should be connected to both positive and negative terminals).

- a) The maximum rating of the fuse connected in series is 25A, and the module-specific ratings are available on the product label and product data sheet.
- b) The fuse rating also corresponds to the maximum reverse current that the module could withstand (when an array is shading, the array is loaded into another parallel module array to generate power), thus the number of parallel connected arrays is affected.
- c) It is forbidden to connect two or more strings in parallel and then share the fuses.

6.0 Maintenance for PV Modules

6.1 Module Visual Inspection and Replacement

Modules in array should be regularly inspected to check damage modules. If damage module is

it must be replaced with same type one. Such as broken glass, broken cables, damaged junction box, etc., which would lead to functional and safety failure of modules.

Well-designed solar systems require minimal maintenance, and some simple steps could be taken to improve system performance and reliability.

6.1.1

Maintenance should be carried out at least once a year by trained person. As system voltage is so high, that maintenance person should always wear rubber gloves and insulated boots. Removing all possible shading of the solar array, which would affect power generation of the module array.

6.1.2

Check if the installed hardware is securely in place.

6.1.3

Check if all array fuses in each of the non-grounded poles are working properly.

6.1.4

If module is damaged (glass breakage or scratches on the back glass), it is need to be replaced. Module must be replaced with same type one. Do not touch the live parts of the cables or connectors when replacing modules. Use appropriate safety guards (insulation tools, insulated gloves, insulated boots, etc.) when handling modules.

6.1.5

Cover the front surface of Modules with an opaque material. Modules exposed under the sun could be extremely dangerous, as high voltages could be generated.

6.1.6

Module junction boxes is equipped with bypass diodes to minimize module heating and current loss.

6.2 Connector and Cable Inspection

6.2.1

Check if all cables are securely connected. It is suggested that all cables should run in proper cable ducts and should be located away from the water-prone area.

6.2.2

Check the electrical, grounding, and mechanical connections every 6 months to ensure that they are clean, safe, free from damage, and rust-free; ensure that the mountings properly tightened; check all cables to make sure they are tight.

6.2.3

It is forbidden to use WD-40 or various organic solvents to wipe all parts of the junction boxes, wires, and connectors.

6.2.4

The dustproof plug should not be removed in advance, it can only be removed during installation.

6.3 Cleaning

The amount of electricity produced by a solar module is proportional to the amount of light reach on surface of it. A dust covered module produces relatively lower power, so it is important to keep module clean.

a) The PV module should be cleaned under the irradiance of less than 200W/m². Avoiding cleaning water with great different temperature from air to avoid cracking. Hard water needs to be softened. The water remains should be removed from glass surface after cleaning.

b) It is strictly forbidden to clean PV modules under special weather: wind level greater four, heavy rain or heavy snow.

c) During cleaning, the water pressure on the surface of module glass shall not exceed 4MPa, and the module is not allowed to withstand additional external force.

d) During cleaning, it is strictly forbidden to step on the modules, splashing water to the back of the modules or cables. Ensure that connectors are clean and dry to prevent electric shock and fire hazard. Steam clean machines are strictly prohibited; soft parts, Cloth and mild detergent and water should be used. Do not put modules directly into the water. Serious thermal shocks also could damage modules.

e) The difficult-to-clean substances such as oil on the surface of modules, use a non-friction neutral liquid cleaner. Do not use any organic solvent containing alkali or acid. Do not use corrosive solvents or wipe the PV modules with a hard object.

f) If you are not sure whether the array need to cleaned, first select a column of particularly dirty array to begin cleaning. If the power generated increased less than 5%, cleaning is usually not required. The above verification should be carried out only under a stable sunshine rate (sunny, strong sunshine, no cloud).

g) The back of the PV module usually does not need to be cleaned; If you need to clean the back of the PV module, ensure that the cleaning liquid does not penetrate into the bottom layer of the material.

h) Regularly trim the vegetation to prevent shading created on the module surface, which would decrease power generation.

6.3.1 Water quality requirements

PH: 5~7;

Chloride or salt content: 0 - 3,000 mg/L;

Turbidity: 0-30 NTU;

Conductivity: 1500~3000 μ s/cm;

Total dissolved solids: \leq 1000 mg/L;

Water hardness: 0-40 mg/L;

Non-alkaline water must be used, use demineralized water when conditions are available.

Note: when using robot clear modules, Jolywood recommends using soft plastic brush. Module damage, poor appearance and power degradation caused by improper robot clear are not within the warranty scope of Jolywood;

6.3.2 Module inspection after cleaning

6.3.2.1

The overall appearance of modules is clean, bright and free of stains. The surface of module should no ash accumulation; there is no obvious scratch on the surface of module. No cracking occurs on the surface of module.

6.3.2.2

The module brackets are not tilted or bent after cleaning, the module terminals are not disconnected.

6.3.2.3

After modules cleaned, complete the PV module cleaning record.

6.3.3 Troubleshooting

If module does not work after installation, please notify the installer immediately.

7.0 Technical Issues or Claims

If you have any questions about technology or claims, please contact the installer.

Please visit <http://www.jolywood.cn/> to contact Jolywood after-sales service team.

Please submit the Customer Feedback Information Form at <http://www.jolywood.cn/>. Our technical service representatives will contact you within 5 working days. The required username and password will be sent via the Customer Service link.

Please download the specifications or data sheets for modules from <http://www.jolywood.cn/>.