

## PV Grid-Connected Inverter

### Quick Installation Guide

**SG25CX-P2 / SG30CX-P2 / SG33CX-P2 /  
SG36CX-P2 / SG40CX-P2 / SG50CX-P2**



- Contents may be periodically updated or revised due to product development. The information in this guide is subject to change without notice. In no case shall this guide substitute for the user manual or related notes on the device.
- Make sure to read over, fully understand and strictly follow the detailed instructions of the user manual and other related regulations. Visit <http://www.sungrowpower.com/>, choose "PV Inverters" and search for the device model on the "Products" tab page to view or obtain the user manual.
- All operations can be performed only by qualified personnel, that must be trained in the installation and commissioning of the electrical system, as well as the dealing with hazards, have knowledge of the manual and of the local regulations and directives.
- Before installation, check that the package contents are intact and complete against the packing list. Contact SUNGROW or the distributor in case of any damaged or missing components.
- The cable must be intact and well insulated. Operation personnel must wear proper personal protective equipment (PPE) all the time.
- Any violation could result in personal death or injury or device damage, and will void the warranty.

## Safety

Please follow the safety instructions related to the PV strings and the utility grid. Otherwise, SUNGROW shall not be held liable for any damage caused.

### DANGER

Lethal voltage!

- PV strings will produce electrical power when exposed to sunlight and can cause a lethal voltage and an electric shock.
- Only qualified personnel can perform the wiring of the PV panels.
- All electrical connections must be in accordance with local and national standards.
- Only with the permission of the utility grid, the inverter can be connected to the utility grid.
- Do not open the enclosure at any time. Unauthorized opening will void guarantee and warranty claims and in most cases terminate the operating license.
- When the enclosure lid is removed, live components can be touched which can result in death or serious injury due to electric shock.

### WARNING

All the warning labels and nameplate on the inverter body must be clearly visible and not be removed, covered or pasted.

### CAUTION

Risk of burns due to hot components!









Do not touch any hot parts (such as heat sinks) during operation. Only the DC switch can safely be touched at any time.

### NOTICE

Only qualified personnel can perform the country setting.

Unauthorized alteration of the country setting may cause a breach of the type-certificate marking.

The symbols on the inverter body are as follows.

	Do not dispose of the inverter together with household waste.		Check the user manual before service!
	CE mark of conformity. EU/EEA Importer.		Additional grounding point.
	TÜV mark of conformity.		Regulatory compliance mark.
	UKCA mark of conformity. The height of the label should not exceed		The inverter does not have a transformer.



Disconnect the inverter from all the external power sources before service!



Danger to life due to high voltages!

Do not touch live parts for 15 minutes after disconnection from the power sources.

Only qualified personnel can open and maintain the inverter.

## Scope of Delivery

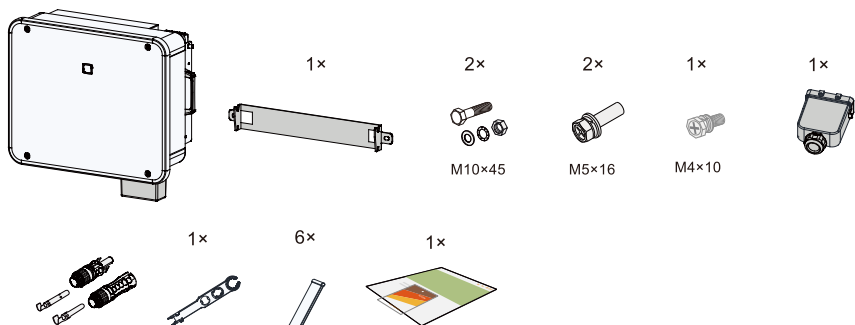

\* The images shown here are for reference. The actual product and quantity are based on delivery.

## Mounting location

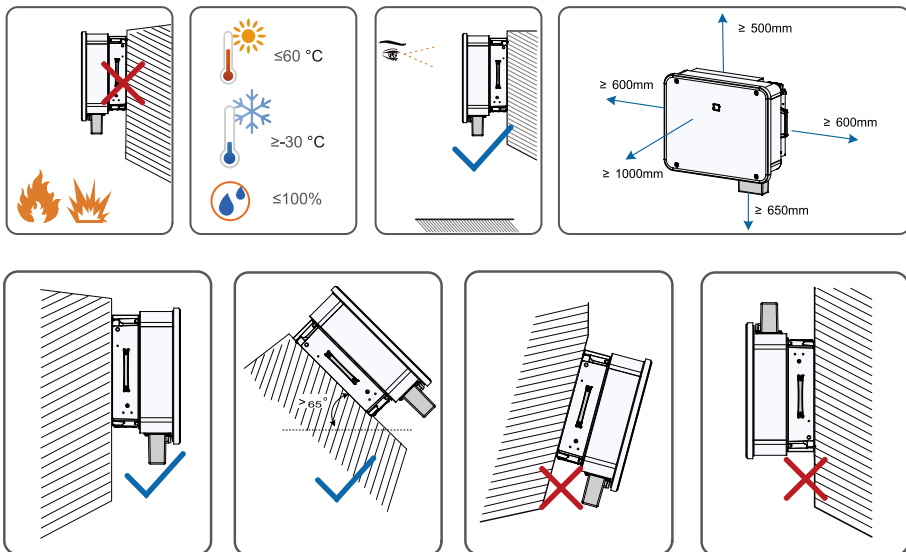

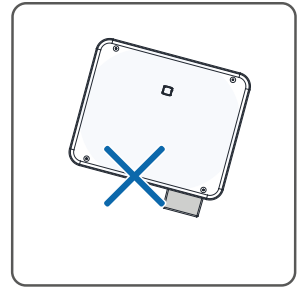
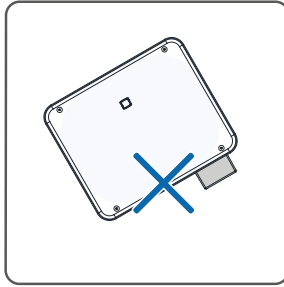
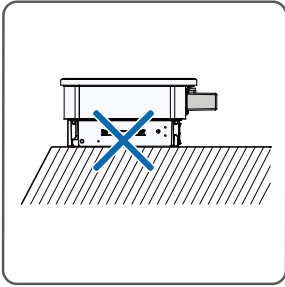

Please consult SUNGROW before tilting backwards the inverter and install it in floating power plants.

## Dimension

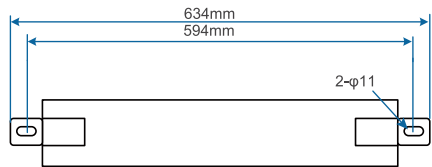
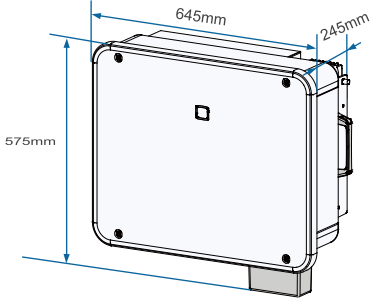

## Mounting

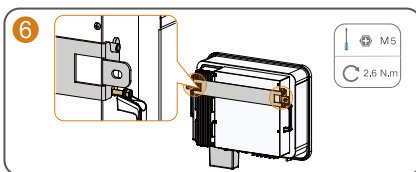
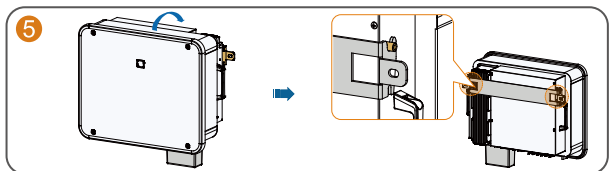
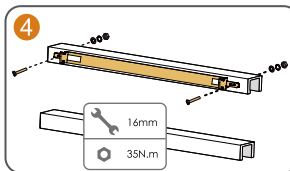
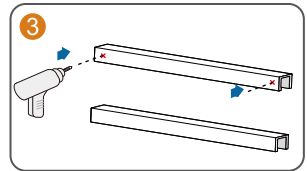
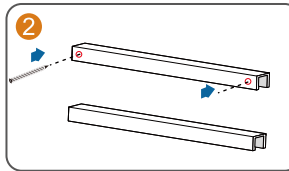
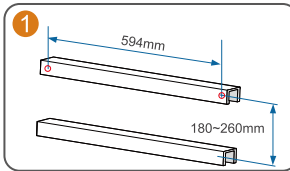

## PE Connection

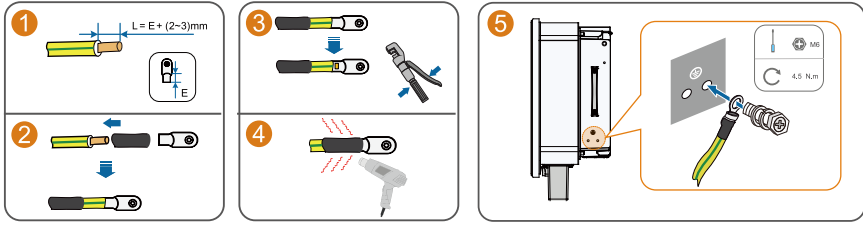

## AC Connection (For a multi-core cable)

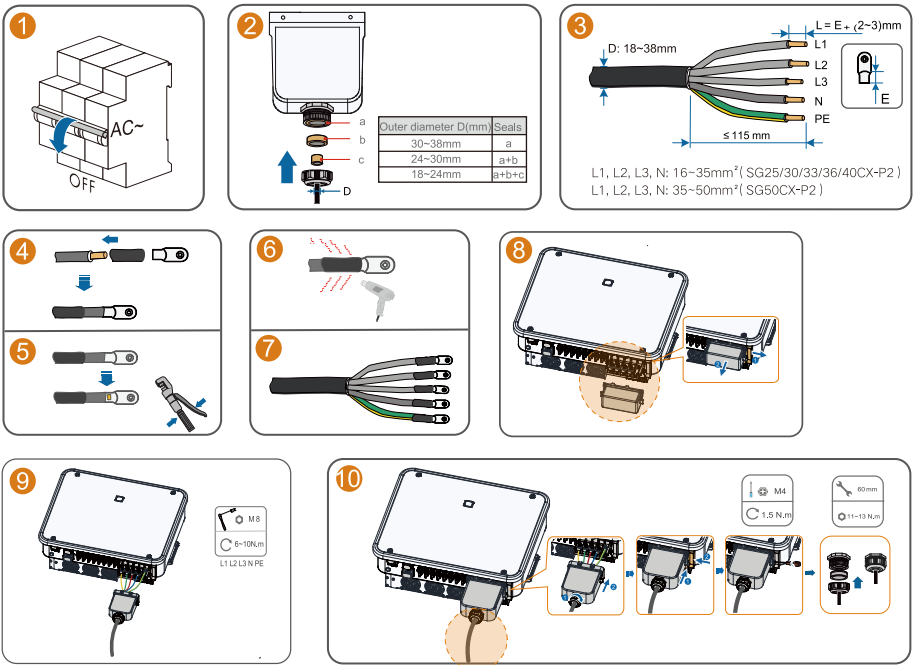

## DC Connection

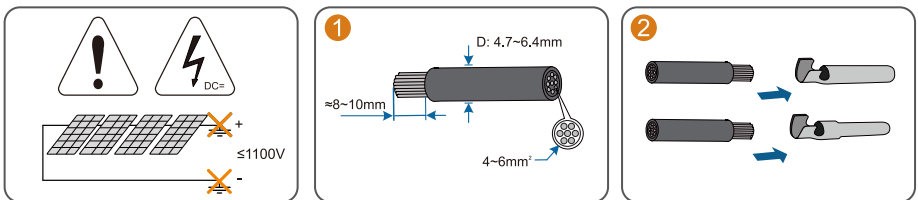

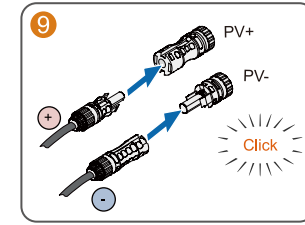
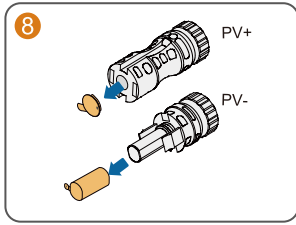
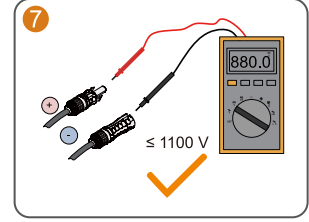
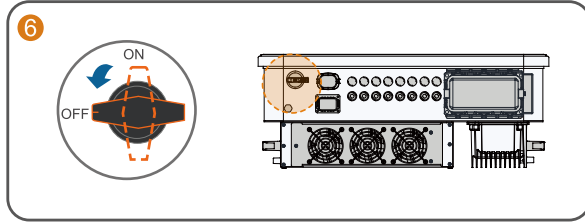
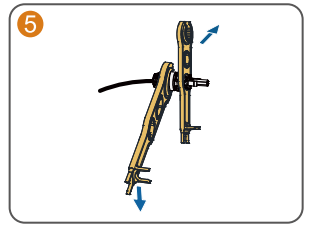
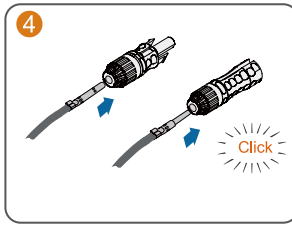
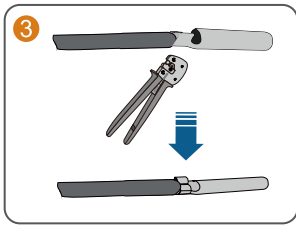

### EyeM4 Connection (optional)

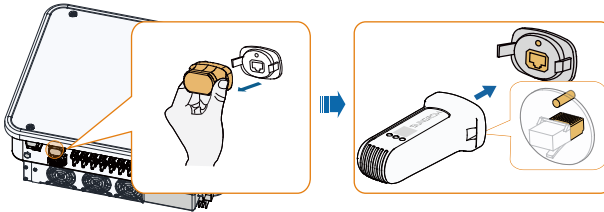

### WiNet-S Connection (optional)

Installation with WLAN communication

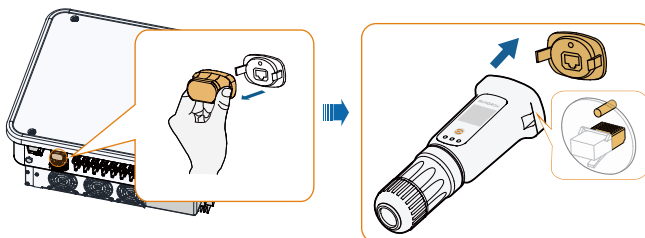

# Installation with Ethernet communication

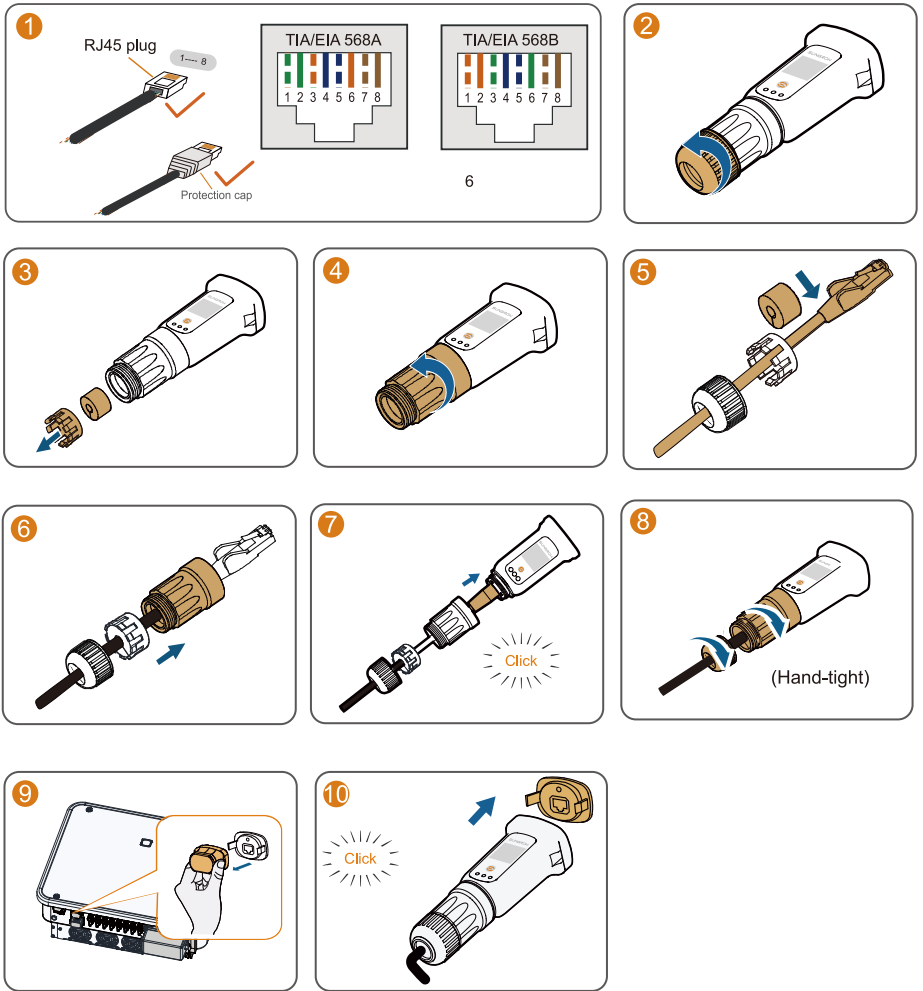

COM2 ( DI , DRM , DO , RS485 , Meter )

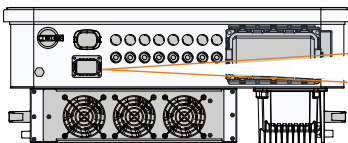

DI		DRM			DO	RS485		Meter
DI	DI	C	D4/8	D2/6	COM	B1	B1	B2
PGND	PGND	R	D3/7	D1/5	NO	A1	A1	A2

## COM2 Connection (DI , DO , RS485 , Meter)

Take meter Connection as an example.

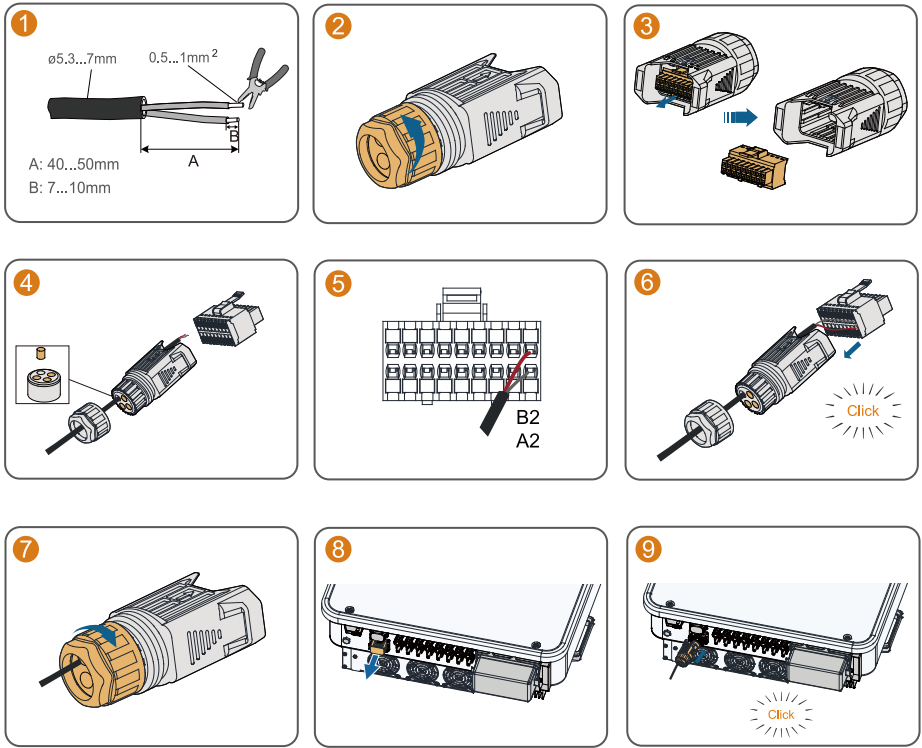

## Inverter parallel

Maximum 30 hybrid inverters with the same type can be connected in parallel.

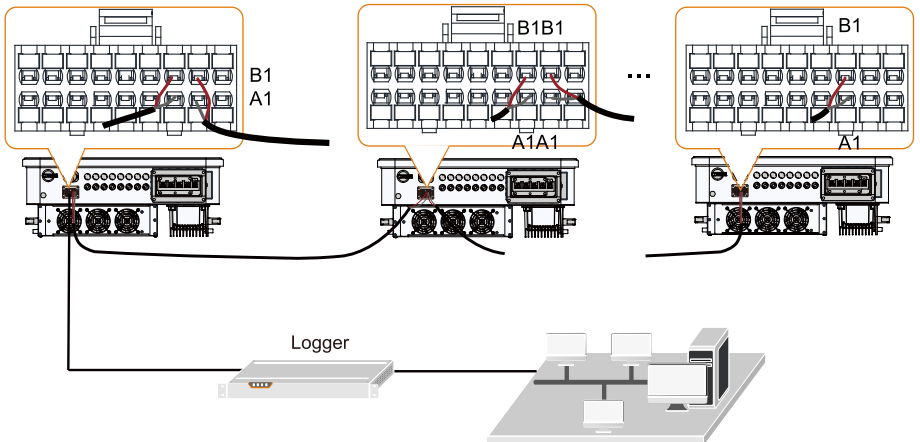



# COM2 Connection (DRM)

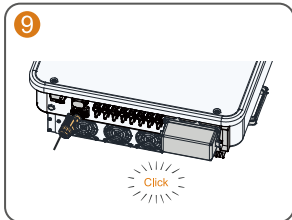
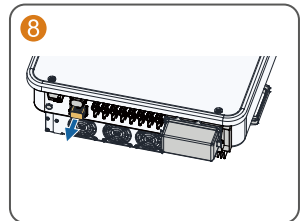
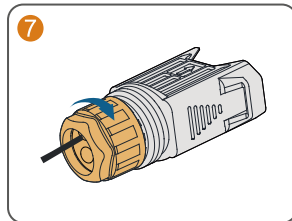
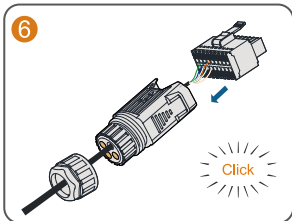
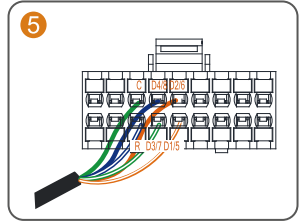
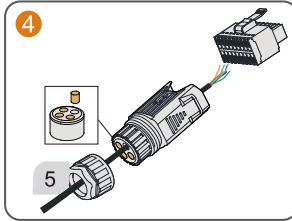
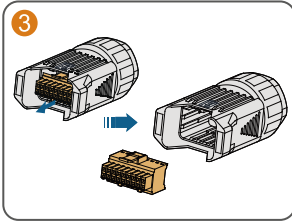
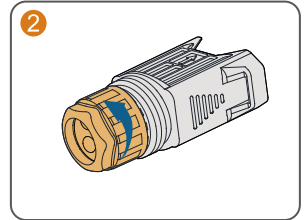
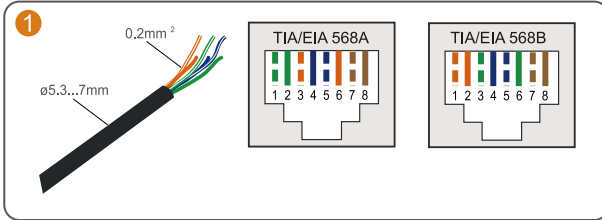

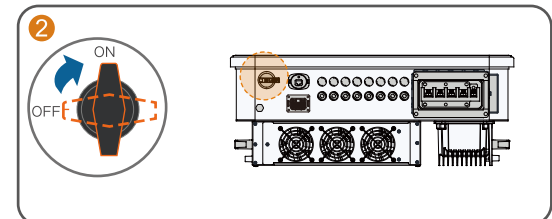
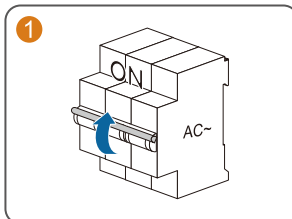

## Power on

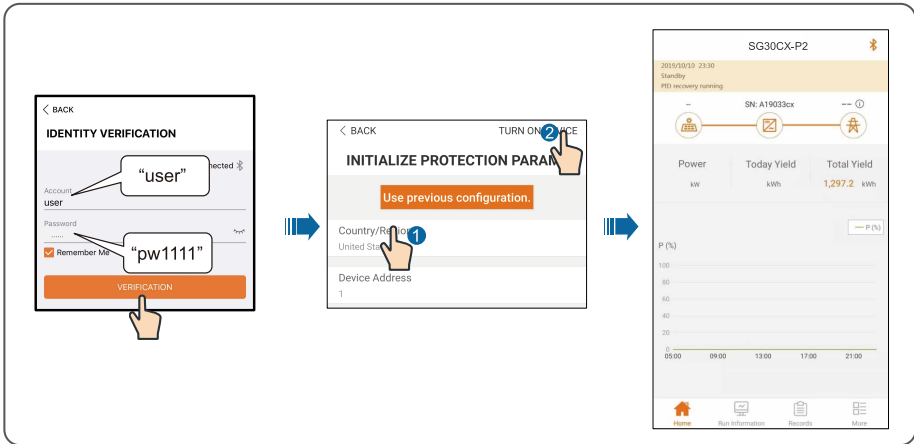
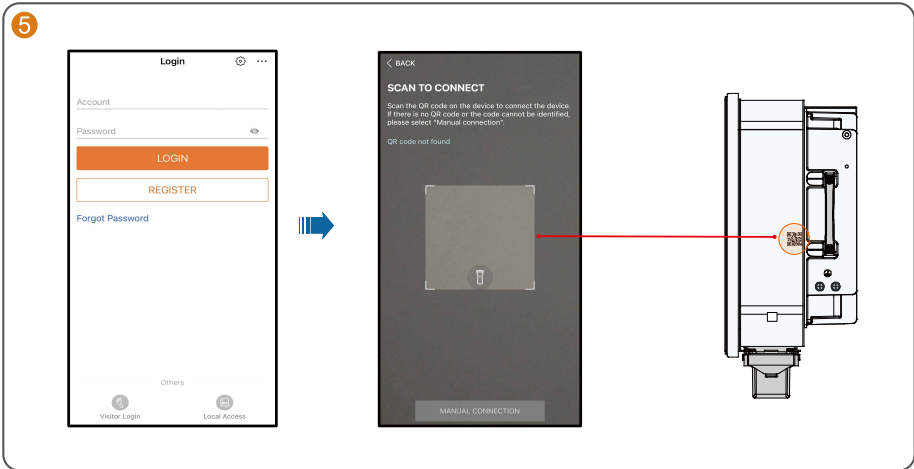
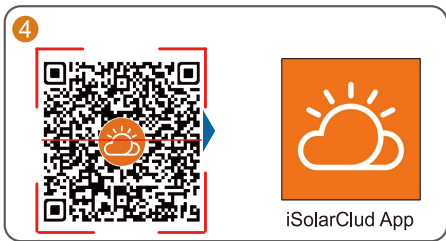
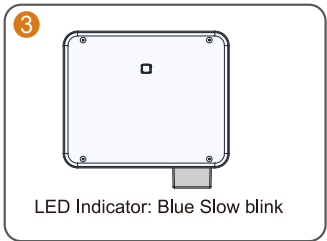



## LED Indicator

LED color	State	Definition
	ON	The device is connected to the grid and operating normally.
	Fast blink (Period: 0.2s)	The Bluetooth communication is connected and there is data communication. No system fault occurs.
	Slow blink (Period: 2s)	The device is in standby or startup state (not feeding power into the grid).
	Slow blink once, fast blink three times	The inverter is performing PID recovery.
	ON	A fault occurs and the device cannot connect to the grid.
	Twinkling	The Bluetooth connection is established, data communication in process, and a system fault occurs.
	OFF	Both the AC and DC sides are powered down.



More information in the QR code or at <http://support.sungrowpower.com/>

**SUNGROW**

Specifications are subject to changes without advance notice.

