

GOODWE



Quick Installation Guide

Smart Dongle

(Ezlink3000)

V1.2-2024-02-01

01 Applications

Single Inverter

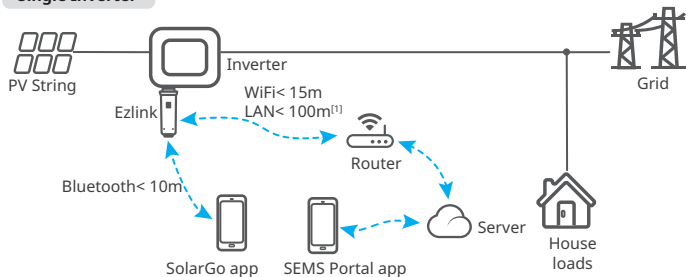

Multiple Inverters

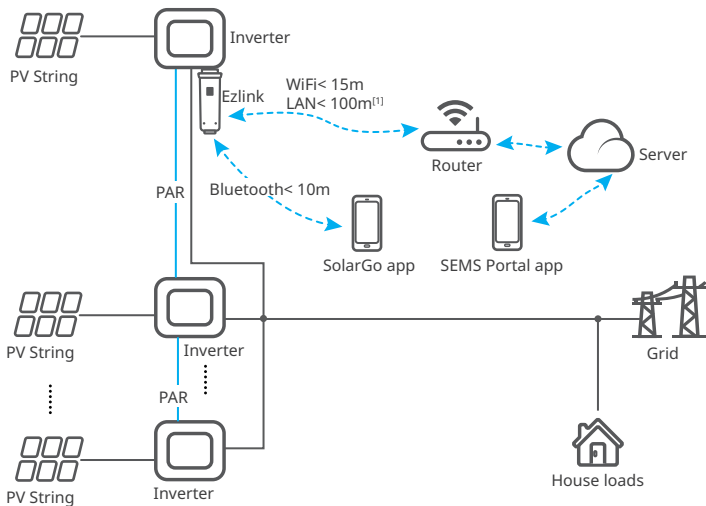

[1] LAN: Optional.

— Power cable — Signal cable

02 Installation

Packing List



Ezlink *1

Unlock tool *N^[1]

User manual *1

(optional)
Waterproof gland
& network cable *1

[1] N=0 or N=1. The number of the unlock tool varies depends on actual situation.

Installing the Dongle

1 2 3 4 5 6: Optional. Only for LAN function. CAT5E or higher shielded outdoor Ethernet cable and RJ45 connector are additionally required.

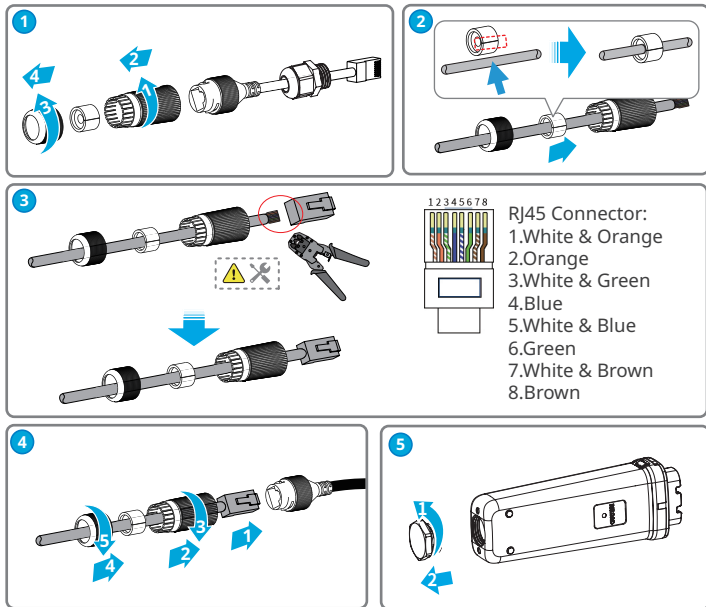

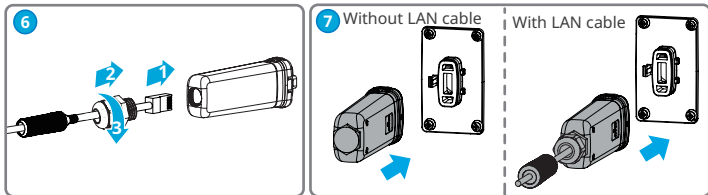







03 Power On

Step 1 Power on the inverter.

Step 2 Power on the router.

Step 3 Check communication status of the Ezlink through indicators.

Note: Check the indicators on the Ezlink and the inverter to confirm the communication status of the device.

Indicator/Silkscreen	Color	Status	Description
	Blue		Blink = The Ezlink is working properly.
			OFF = The Ezlink is powered off.
	Green		ON = The Ezlink is connected to the server.
			Blink 2 = The Ezlink is not connected to the router.
			Blink 4 = The Ezlink is connected to the router, but not connected to the server.
RELOAD	-	-	Short press for 3s to restart the Ezlink. Long press for 3-10s to restore factory settings.

04 Commissioning via SolarGo App

Step 1 Download and install SolarGo app.

The UI may be different due to the app version upgrade. Scan the QR code for latest SolarGo app user manual.



SolarGo App



SolarGo User Manual

Step 2 Connect the app and the device (CCM-BLE*** or CCM-***).

(Optional) When multiple inverters are parallel connected, refer to the user manual of the inverter for more system commission details.

Step 3 Tap **Home > Settings > Communication Setting** to set communication settings of the device based on actual needs, like enable or disable WiFi, enable or disable LAN, set network parameters, enable or disable DHCP etc. For more details, refer to the **Configuring Communication Parameters** section in the **SolarGo App User Manual**.

- The interface may differ depending on the communication method.
- Make sure that the WiFi RSSI value is higher than -60, it would be better if it is -50 or higher. When the RSSI value is less than -60, you should move the router closer to the device, remove the obstacle, or add a repeater to improve the signal strength.

05 Device Replacement

Step 1 Prepare a new device before replacing the old Ezlink.

Step 2 Press the unlock button or use the unlock tool to remove the Ezlink.

Method I

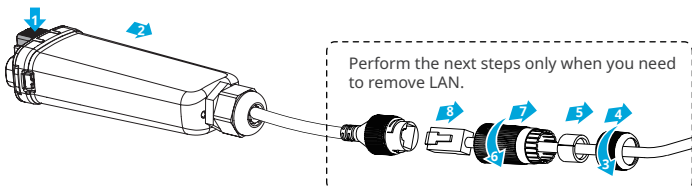



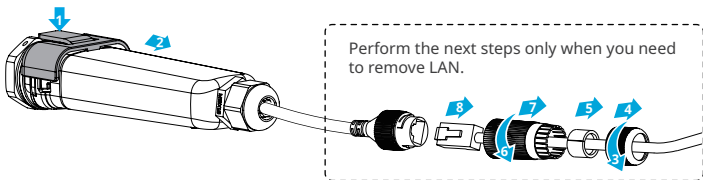

Method II



Step 3 Refer to the Quick Installation Guide to install and configure the new device.

06 Troubleshooting

No.	Problem	Solutions
1	Cannot find CCM-BLE** or CCM-**	<ol style="list-style-type: none"> 1. Make sure that no other smart device is connected to CCM-BLE** or CCM-**. 2. Make sure that the SolarGo app is the latest version.
2	Unable to connect to CCM-BLE** or CCM-**	<ol style="list-style-type: none"> 1. Make sure that no other smart device is connected to CCM-BLE** or CCM-**. 2. Restart the inverter or short press to restart the Ezlink, then reconnect CCM-BLE** or CCM-**.
3	 Indicator double blink	<ol style="list-style-type: none"> 1. Make sure that the router is powered on. 2. When communicating via LAN, make sure that both LAN cable connection and LAN configuration are proper. Enable or disable DHCP based on actual needs. 3. When communicating via WiFi, make sure that the wireless network connection is ok and the wireless signal strength meets the requirements. Enable or disable DHCP based on actual needs.
4	 Indicator quadruple blink	<ol style="list-style-type: none"> 1. Make sure that the Ezlink is connected to the router via WiFi or LAN properly, and the router can access the internet. 2. If the problem persists, contact the after sales service.
5	 Indicator off	Check whether the inverter is powered on. If the problem persists, contact the after sales service.
6	 Indicator off	Check whether the inverter is powered on. If the problem persists, contact the after sales service.

07 Technical Data

EN

	Model	Ezlink3000
General Parameters	Connection Interface	USB
	Ethernet Interface (Optional)	10/100Mbps self-adaption, Communcation distance $\leq 100\text{m}$
	Installation	Plug-and-play
	Indicator	LED Indicator
	Dimensions (W × H ×D mm)	49 × 153 × 32
	Weight (g)	130
	Ingress Protection Rating	IP65
	Power Consumption (W)	≤ 2 (typical)
	Operation Mode	STA
Wireless Parameters	Bluetooth Communication	Bluetooth 5.1
	WiFi Communication	802.11 b/g/n(2.412GHz-2.484GHz)
Environment Parameters	Operating Temperature Range (°C)	-30 ~ +60
	Storage Temperature Range (°C)	-30 ~ +70
	Relative Humidity	0-100% (non-condensing)
	Max. Operating Altitude (m)	4000

08 EU Declaration of Conformity

EN

GoodWe Technologies Co., Ltd. hereby declares that the communication device sold in the European market meets the requirements of the following directives:

- Radio Equipment Directive 2014/53/EU (RED)
- Restrictions of Hazardous Substances Directive 2011/65/EU and (EU) 2015/863 (RoHS)
- Waste Electrical and Electronic Equipment 2012/19/EU
- Registration, Evaluation, Authorization and Restriction of Chemicals (EC) No 1907/2006 (REACH)

You can download the EU Declaration of Conformity on <https://en.goodwe.com>.

For more information, scan the QR codes below.



SolarGo App

SolarGo User
ManualSEMS Portal
AppSEMS Portal app
User Manual

07 Технически данни**BG**

	Модел	Ezlink3000
Основни параметри	Интерфейс за свързване	USB
	Ethernet интерфейс (незадължителен)	10/100 Mbps саморегулиране, Разстояние на комуникация ≤ 100 m
	Инсталиране	Включи и работи (Plug and Play)
	Индикатор	LED индикатор
	Размери (Ш × В × Д mm)	49 × 153 × 32
	Тегло (g)	130
	Степен на защита от проникване	IP65
	Консумирана мощност (W)	≤ 2
Параметри на безжичната връзка	Bluetooth	Bluetooth 5.1
	WiFi комуникация	802.11 b/g/n (2,412 GHz - 2,484 GHz)
Параметри на околната среда	Работна температура (°C)	-30 ~ +60
	Температура на съхранение (°C)	-30 ~ +70
	Относителна влажност	0-100% (без конденз)
	Макс. работна надморска височина (m)	4000
	Режим на работа	STA

08 ЕС декларация за съответствие**BG**

С настоящото, GoodWe Technologies Co., Ltd. декларира, че устройството за безжична комуникация, продавано на европейския пазар, отговаря на изискванията на следните директиви:

- Директива 2014/53/ЕС за радиосъоръженията (RED)
- Директива за ограничаване на опасните вещества 2011/65/ЕС и (ЕС) 2015/863 (RoHS)
- Отпадъци от електрическо и електронно оборудване 2012/19/ЕС
- Регламент относно регистрацията, оценката, разрешаването и ограничаването на химикали (EO) № 1907/2006 (REACH)

Можете да изтеглите ЕС декларацията за съответствие на адрес <https://en.goodwe.com>.

For more information, scan the QR codes below.



SolarGo App



SolarGo User Manual



SEMS Portal App



SEMS Portal app User Manual

07 Technické údaje

CS

	Model	Ezlink3000
Obecné parametry	Rozhraní připojení	USB
	Rozhraní Ethernet (volitelné)	Samostatné přizpůsobení 10/100 Mb/s, Komunikační vzdálenost ≤100m
	Instalace	Plug-and-play
	Kontrolka	Indikátor LED
	Rozměry (Š × V × H mm)	49 × 153 × 32
	Hmotnost (g)	130
	Stupeň ochrany krytem	IP65
	Příkon (W)	≤2
	Provozní režim	STA
Bezdrátové připojení Parametry	Bluetooth	Bluetooth 5.1
	Komunikace WiFi	802.11 b/g/n (2,412 Ghz – 2,484 GHz)
Prostředí Parametry	Rozsah provozních teplot (°C)	-30 ~ +60
	Rozsah skladovacích teplot (°C)	-30 ~ +70
	Relativní vlhkost	0–100 % (nekondenzující)
	Max. provozní nadmořská výška (m)	4000

08 EU prohlášení o shodě

CS

Společnost GoodWe Technologies Co., Ltd. tímto prohlašuje, že komunikační zařízení prodávané na evropském trhu splňuje požadavky následujících směrnic:

- Směrnice o rádiových zařízeních 2014/53/EU (RED)
- Směrnice 2011/65/EU a (EU) 2015/863 o omezení používání některých nebezpečných látek (RoHS)
- Směrnice 2012/19/EU o odpadních elektrických a elektronických zařízeních
- Nařízení (ES) č. 1907/2006 o registraci, hodnocení, povolování a omezování chemických látek (REACH)

EU prohlášení o shodě si můžete stáhnout na stránce <https://en.goodwe.com>.

For more information, scan the QR codes below.



SolarGo App



SolarGo User Manual



SEMS Portal App



SEMS Portal app User Manual

07 Tekniske data

DA

	Model	Ezlink3000
Generelle parametre	Grænseflade for tilslutning	USB
	Ethernet-grænseflade (valgfrit)	10/100Mbps selvtilpasning, Kommunikationsafstand ≤100m
	Installation	Plug-and-play
	Indikator	LED-indikator
	Dimensioner (B × H × D mm)	49 × 153 × 32
	Vægt (g)	130
	Klassificering for indtrængningsbeskyttelse	IP65
	Strømforbrug (W)	≤2
	Driftstilstand	STA
Trådløs Parametre	Bluetooth	Bluetooth 5.1
	WiFi-kommunikation	802.11 b/g/n(2.412GHz-2.484GHz)
Miljø Parametre	Driftstemperaturområde (°C)	-30 ~ +60
	Opbevaringstemperaturområde (°C)	-30 ~ +70
	Relativ luftfugtighed	0-100% (ikke-kondenserende)
	Maks. driftshøjde (m)	4000

08 EU-overensstemmelseserklæring

DA

GoodWe Technologies Co., Ltd. erklærer hermed, at den kommunikationsenhed, der sælges på det europæiske marked, opfylder kravene i følgende direktiver:

- Direktiv om radioudstyr 2014/53/EU (RED)
- Direktivet om begrænsning af farlige stoffer 2011/65/EU og (EU) 2015/863 (RoHS)
- Affald fra elektrisk og elektronisk udstyr 2012/19/EU
- Registrering, vurdering, godkendelse og begrænsning af kemiske stoffer (EF) nr. 1907/2006 (REACH)

Du kan downloade EU-overensstemmelseserklæringen på <https://en.goodwe.com>.

For more information, scan the QR codes below.



SolarGo App



SolarGo User Manual



SEMS Portal App



SEMS Portal app User Manual

07 Technische Daten**DE**

	Modell	Ezlink3000
Allgemeine Parameter	Verbindungsschnittstelle	USB
	Ethernet-Schnittstelle (Zubehör)	10/100 Mbps autoadaptiv, Kommunikationsstrecke ≤100 m
	Aufbau	Plug and Play
	Anzeige	LED-Anzeige
	Abmessungen (B×H×T mm)	49 × 153 × 32
	Gewicht (g)	130
	Schutzart gegen Eindringen	IP65
	Leistungsaufnahme (W)	≤2
Kabellos Parameter	Bluetooth	Bluetooth 5.1
	WLAN-Kommunikation	802.11 b/g/n (2,412 GHz - 2,484 GHz)
Umgebung Parameter	Betriebstemperaturbereich (°C)	-30 - +60
	Lagertemperaturbereich (°C)	-30 - +70
	Relative Luftfeuchtigkeit	0 - 100 % (ohne Betauung)
	Max. Betriebshöhe (m)	4000

08 EU-Konformitätserklärung**DE**

GoodWe Technologies Co., Ltd. versichert hiermit, dass das auf dem europäischen Binnenmarkt verkaufte Kommunikationsgerät die Anforderungen der folgenden Richtlinien erfüllt:

- Funkanlagenrichtlinie 2014/53/EU
- Richtlinien 2011/65/EU und (EU) 2015/863 (RoHS) zur Beschränkung der Verwendung bestimmter gefährlicher Stoffe
- Elektro- und Elektronik-Altgeräte 2012/19/EU
- Registrierung, Bewertung, Zulassung und Beschränkung von Chemikalien (EG) Nr. 1907/2006 (REACH)

Die EU-Konformitätserklärung ist als Download verfügbar unter <https://en.goodwe.com>.

For more information, scan the QR codes below.



SolarGo App



SolarGo User Manual



SEMS Portal App



SEMS Portal app User Manual

07 Τεχνικά δεδομένα**EL**

	Μοντέλο	Ezlink3000
Γενικές παράμετροι	Διεπαφή σύνδεσης	USB
	Διεπαφή Ethernet (Προαιρετικό)	Αυτοπροσαρμογή σε 10 / 100 Mbps, Απόσταση επικοινωνίας ≤100 m
	Εγκατάσταση	Τοποθέτηση και άμεση λειτουργία
	Ένδειξη	Ένδειξη LED
	Διαστάσεις (Π × Υ × Β mm)	49 × 153 × 32
	Βάρος (g)	130
	Δείκτης προστασίας από εισχώρηση	IP65
	Κατανάλωση ισχύος (W)	≤2
	Τρόπος λειτουργίας	STA
Ασύρματη Παράμετροι	Bluetooth	Bluetooth 5.1
	Επικοινωνία WiFi	802,11 b/g/n (2,412 GHz - 2,484 GHz)
Περιβάλλον Παράμετροι	Εύρος θερμοκρασίας λειτουργίας (°C)	-30 ~ +60
	Εύρος θερμοκρασίας φύλαξης (°C)	-30 ~ +70
	Σχετική υγρασία	0-100% (χωρίς συμπύκνωση)
	Μέγιστο υψόμετρο λειτουργίας (m)	4.000

08 Δήλωση συμμόρφωσης ΕΕ**EL**

Η GoodWe Technologies Co., Ltd. διά του παρόντος δηλώνει ότι η συσκευή επικοινωνίας που πωλείται στην αγορά της Ευρώπης πληροί τις απαιτήσεις των παρακάτω Οδηγιών:

- Οδηγία 2014/53/ΕΕ για τον ραδιοεξοπλισμό (RED)
- Οδηγία 2011/65/ΕΕ και (ΕΕ) 2015/863 σχετικά με τον περιορισμό της χρήσης επικίνδυνων ουσιών (RoHS)
- Οδηγία 2012/19/ΕΕ σχετικά με τα απόβλητα ηλεκτρικού και ηλεκτρονικού εξοπλισμού
- Καταχώριση, αξιολόγηση, αδειοδότηση και περιορισμοί των χημικών προϊόντων (ΕΚ) αρ. 1907/2006 (REACH)

Μπορείτε να πραγματοποιήσετε λήψη της Δήλωσης συμμόρφωσης ΕΕ στη διεύθυνση

<https://en.goodwe.com>.

For more information, scan the QR codes below.



SolarGo App

SolarGo User
ManualSEMS Portal
AppSEMS Portal app
User Manual

07 Datos técnicos**ES**

	Modelo	Ezlink3000
Parámetros generales	Interfaz de conexión	USB
	Interfaz de Ethernet (opcional)	Autoadaptación 10/100Mbps, Distancia de comunicación ≤100m
	Instalación	Plug-and-play
	Indicador	Indicador LED
	Dimensiones (An × Al × P mm)	49 × 153 × 32
	Peso (g)	130
	Grado de protección IP	IP65
	Consumo (W)	≤2
Inalámbrico Parámetros	Modo de funcionamiento	STA
	Bluetooth	Bluetooth 5.1
	Comunicación por wifi	802.11 b/g/n(2.412GHz-2.484GHz)
Entorno Parámetros	Intervalo de temperaturas de funcionamiento (°C)	-30 ~ +60
	Intervalo de temperaturas de almacenamiento (°C)	-30 ~ +70
	Humedad relativa	0-100% (sin condensación)
	Máx. altitud de funcionamiento (m)	4000

08 Declaración de conformidad de la UE**ES**

GoodWe Technologies Co., Ltd. declara por la presente que el dispositivo de comunicación comercializado en el mercado europeo cumple los requisitos de las siguientes directivas:

- Directiva sobre equipos radioeléctricos 2014/53/UE (RED)
- Directiva sobre restricciones a sustancias peligrosas 2011/65/UE y (UE) 2015/863 (RoHS)
- Residuos de aparatos eléctricos y electrónicos 2012/19/UE
- Registro, evaluación, autorización y restricción de sustancias químicas (CE) n.º 1907/2006 (REACH)

Puede descargar la Declaración de conformidad de la UE en <https://en.goodwe.com>.

For more information, scan the QR codes below.



SolarGo App



SolarGo User Manual



SEMS Portal App



SEMS Portal app User Manual

07 Tehnilised andmed**ET**

	Mudel	Ezlink3000
Üldised Parameetrid	Ühendusliides	USB
	Etherneti liides (vabatahtlik)	10/100Mbps isekohastav, Sideühenduskaugus ≤100m
	Bluetooth	Bluetooth 5.1
	Paigaldamine	Ühenda-ja-mängi
	Indikaator	LED-indikaator
	Mõõtmed (L × K × S)	49 × 153 × 32
	Kaal (g)	130
	IP-kaitseklass	IP65
	Võimsustarve (W)	≤2
	Töörežiim	STA
WiFi Parameetrid	Bluetooth	Bluetooth 5.1
	WiFi side	802,11 b/g/n(2,412GHz-2,484GHz)
Keskond Parameetrid	Töötemperatuuri vahemik (°C)	-30 ~ +60
	Hoiustamistemperatuuri vahemik (°C)	-30 ~ +70
	Suhteline õhuniiskus	0-100% (mittekondenseeruv)
	Kasutuskoha max kõrgus merepinnast (m)	4 000

08 EL-i vastavusdeklaratsioon**ET**

GoodWe Technologies Co., Ltd. deklareerib käesolevaga, et Euroopa turul müüdav sideaseade vastab järgmiste direktiivide nõuetele:

- Raadioseadmete direktiiv 2014/53/EL (RED)
- Ohtlike ainete kasutamise piirangute direktiiv 2011/65/EL ja (EL) 2015/863 (RoHS)
- Elektri- ja elektroonikaseadmete jäätmed 2012/19/EL
- Kemikaalide registreerimine, hindamine, autoriseerimine ja piiramine (EÜ) nr 1907/2006 (REACH)

ELi vastavusdeklaratsiooni saate alla laadida aadressil <https://en.goodwe.com>.

For more information, scan the QR codes below.



SolarGo App

SolarGo User
ManualSEMS Portal
AppSEMS Portal app
User Manual

07 Tekniset tiedot

FI

	Malli	Ezlink3000
Yleiset parametrit	Yhteysrajapinta	USB
	Ethernet-rajapinta (valinnainen)	10/100Mbps itsesovittuva, tiedonsiirtoetäisyys ≤100 m
	Asennus	Liitä ja käytä
	Merkkivalo	LED-merkkivalo
	Mitat (L × K × S)	49 × 153 × 32
	Paino (g)	130
	Kotelointiluokka	IP65
	Tehonkulutus (W)	≤ 2
	Toimintatila	STA
Langattomat parametrit	Bluetoothc	Bluetooth 5.1
	WiFi-tiedonsiirto	802.11 b/g/n (2,412 GHz–2,484 GHz)
Ympäristö parametrit	Käyttölämpötila-alue (°C)	-30 ~ +60
	Varastointilämpötila-alue (°C)	-30 ~ +70
	Suhteellinen kosteus	0–100 % (ei kondensoituvaa)
	Enimmäiskäyttökorkeus (m)	4 000

08 EU-vaatimustenmukaisuusvakuutus

FI

GoodWe Technologies Co., Ltd. vakuuttaa, että Euroopan markkinoilla myytävä tiedonsiirtolaite täyttää seuraavien direktiivien vaatimukset:

- Radiolaitedirektiivi 2014/53/EU (RED)
- Vaarallisten aineiden käytön rajoittaminen 2011/65/EU ja (EU) 2015/863 (RoHS)
- Sähkö- ja elektroniikkalaiteromu 2012/19/EU
- Kemikaalien rekisteröinti, arviointi, lupamenettely ja rajoitukset (EY) nro 1907/2006 (REACH)

Voit ladata EU-vaatimustenmukaisuusvakuutuksen osoitteesta <https://en.goodwe.com>.

For more information, scan the QR codes below.



SolarGo App



SolarGo User Manual



SEMS Portal App



SEMS Portal app User Manual

07 Données techniques**FR**

	Modèle	Ezlink3000
Paramètres généraux	Interface de connexion	USB
	Interface Ethernet (facultatif)	Adaptation automatique 10/100 Mbps/s, Distance de commuc
	Installation	Plug-and-Play
	Voyant	Voyant LED
	Dimensions (l × h × p mm)	49 × 153 × 32
	Poids (g)	130
	Indice de protection	IP65
	Consommation électrique (W)	≤ 2
	Mode de fonctionnement	STA
Paramètres de connexion sans fil	Bluetooth	Bluetooth 5.1
	Communication Wi-Fi	802.11 b/g/n (2,412 GHz-2,484 GHz)
Paramètres d'environnement	Plage de température de fonctionnement (°C)	-30 à +60
	Plage de température de stockage (°C)	-30 à + 70
	Humidité relative	0 à 100 % (sans condensation)
	Altitude d'exploitation max. (m)	4 000

08 Déclaration de conformité UE**FR**

GoodWe Technologies Co., Ltd. déclare par la présente que le dispositif de communication vendu sur le marché européen est conforme aux exigences des directives suivantes :

- Directive concernant les équipements radio 2014/53/UE (RED)
- Directive sur la restriction des substances dangereuses 2011/65/UE et (UE) 2015/863 (RoHS)
- Déchets d'équipements électriques et électroniques 2012/19/UE
- Enregistrement, évaluation, autorisation et restriction des substances chimiques (CE) n° 1907/2006 (REACH)

Vous pouvez télécharger la déclaration de conformité UE sur <https://en.goodwe.com>.

For more information, scan the QR codes below.



SolarGo App

SolarGo User
ManualSEMS Portal
AppSEMS Portal app
User Manual

07 Tehnički podaci**HR**

	Model	Ezlink3000
Opći parametri	Sučelje za povezivanje	USB
	Ethernet sučelje (opcija)	10/100 Mbps samoprilagodba, Komunikacijska udaljenost ≤100 m
	Instalacija	Uključi i radi
	Indikator	LED indikator
	Dimenzije (Š × V × D mm)	49 × 153 × 32
	Težina (g)	130
	Stupanj zaštite elektroničke opreme	IP65
	Potrošnja energije (W)	≤2
	Režim rada	STA
Bežično Parametri	Bluetooth	Bluetooth 5.1
	WiFi komunikacija	802.11 b/g/n (2,412 GHz-2,484 GHz)
Okolina Parametri	Raspon radne temperature (°C)	-30 ~ +60
	Raspon temperature skladištenja (°C)	-30 ~ +70
	Relativna vlažnost	0-100 % (bez kondenzacije)
	Maks. radna visina (m)	4000

08 EU izjava o sukladnosti**HR**

Tvrtka GoodWe Technologies Co., Ltd. ovime izjavljuje da komunikacijski uređaj koji se prodaje na europskom tržištu ispunjava zahtjeve sljedećih direktiva:

- Direktiva o radijskoj opremi (RED) 2014/53/EU
 - Direktiva o ograničenju opasnih tvari 2011/65/EU i (EU) 2015/863 (RoHS)
 - Otpadna električna i elektronička oprema 2012/19/EU
 - Registracija, evaluacija, autorizacija i ograničavanje kemikalija (EZ) br. 1907/2006 (REACH)
- Izjavu EU o sukladnosti možete preuzeti na <https://en.goodwe.com>.

For more information, scan the QR codes below.



SolarGo App

SolarGo User
ManualSEMS Portal
AppSEMS Portal app
User Manual

07 Műszaki adatok

HU

	Modell	Ezlink3000
Általános paraméterek	Csatlakozási felület	USB
	Ethernet-interfész (opcionális)	10/100 Mbps önálló alkalmazkodás, Kommunikációs távolság ≤100m
	Telepítés	Csatlakoztatás után azonnal használható
	Indikátor	LED indikátor
	Méreték (Sz×Ma×Mé mm)	49 × 153 × 32
	Súly (g)	130
	Behatolásvédelmi besorolás	IP65
	Áramfogyasztás (W)	≤2
	Üzem mód	STA
Vezeték nélküli Paraméterek	Bluetooth	Bluetooth 5c
	Wi-Fi-kommunikáció	802.11 b/g/n (2,412 GHz-2,484 GHz)
Környezet Paraméterek	Üzemihőmérséklet-tartomány (°C)	-30 ~ +60
	Tárolási hőmérséklet-tartomány (°C)	-30 ~ +70
	Relatív páratartalom	0-100% (nem lecsapódó)
	Max. üzemi - tengerszint feletti - magasság (m)	4000

08 EU-megfelelőségi nyilatkozat

HU

A GoodWe Technologies Co., Ltd. ezennel kijelenti, hogy az európai piacon értékesített, kommunikációs berendezés megfelel az alábbi irányelvek követelményeinek:

- Rádióberendezésekről szóló 2014/53/EU irányelv (RED)
- A veszélyes anyagok korlátozásáról szóló 2011/65/EU irányelv és (EU) 2015/863 irányelv (RoHS-irányelv)
- Az elektromos és elektronikus berendezések hulladékairól szóló 2012/19/EU irányelv
- A vegyi anyagok regisztrálásáról, értékeléséről, engedélyezéséről és korlátozásáról (REACH) szóló 1907/2006/EK rendelet (REACH-rendelet)

Az EU-megfelelőségi nyilatkozatot a <https://en.goodwe.com> weboldalról töltheti le.

For more information, scan the QR codes below.



SolarGo App



SolarGo User Manual



SEMS Portal App



SEMS Portal app User Manual

07 Dati tecnici**IT**

	Modello	Ezlink3000
Parametri generali	Interfaccia collegamento	USB
	Interfaccia Ethernet (optional)	Autoadattamento 10/100Mbps, distanza comunicazione ≤100m
	Installazione	Plug and Play
	Indicatore	Indicatore LED
	Dimensioni (L × A × P mm)	49 × 153 × 32
	Peso (g)	130
	Grado di protezione dall'ingresso	IP65
	Consumo di energia (W)	≤2
Wireless Parametri	Modo operativo	STA
	Bluetooth	Bluetooth 5.1
	Comunicazione WiFi	802.11 b/g/n(2.412GHz-2.484GHz)
Ambiente Parametri	Intervallo di temperatura operativa (°C)	-30 ~ +60
	Intervallo di temperatura di conservazione (°C)	-30 ~ +70
	Umidità relativa	0-100% (senza condensa)
	Altitudine operativa max. (m)	4000

08 Dichiarazione di conformità UE**IT**

GoodWe Technologies Co., Ltd. dichiara che il dispositivo di comunicazione venduto sul mercato europeo soddisfa i requisiti delle seguenti direttive:

- Direttiva 2014/53/UE (RED) sulle apparecchiature radio
- Direttiva sulla restrizione delle sostanze pericolose 2011/65/UE e (UE) 2015/863 (RoHS)
- Rifiuti di apparecchiature elettriche ed elettroniche 2012/19/UE
- Registrazione, valutazione, autorizzazione e restrizione delle sostanze chimiche (CE) n. 1907/2006 (REACH)

È possibile scaricare la dichiarazione di conformità UE su <https://en.goodwe.com>.

For more information, scan the QR codes below.



SolarGo App



SolarGo User Manual



SEMS Portal App



SEMS Portal app User Manual

07 Techniniai duomenys**LT**

	Modelis	Ezlink3000
Bendrieji parametrai	Ryšio sąjaja	USB
	Ethernet sąjaja (pasirinktinai)	10/100Mbps savaiminis prisitaikymas, Ryšio atstumas ≤100m
	Instaliavimas	Prijunkite ir paleiskite
	Indikatorius	Šviesadiodis indikatorius
	Matmenys (P × A × G mm)	49 × 153 × 32
	Svoris (g)	130
	Apsaugos klasė	IP65
	Energijos sąnaudos (W)	≤2
	Darbo režimas	STA
Belaidis Kriterijai	Bluetooth	Bluetooth 5.1
	WiFi komunikacija	802,11 b/g/n (2,412GHz-2,484GHz)
Aplinka Kriterijai	Darbinės temperatūros diapazonas (°C)	-30 ~ +60
	Laikymo temperatūros diapazonas (°C)	-30 ~ +70
	Santykinė drėgmė	0-100% (be kondensato)
	Didž. darbinis aukštis (m)	4000

08 ES atitikties deklaracija**LT**

GoodWe Technologies Co., Ltd. pareiškia, kad Europos rinkoje parduodamas ryšio įrenginys atitinka šių direktyvų reikalavimus:

- Radijo įrangos direktyva 2014/53/EU (RED)
- Pavojingų medžiagų apribojimo direktyvą 2011/65/EU ir (EU) 2015/863 (RoHS)
- Elektros ir elektroninės įrangos atliekos 2012/19/ES
- Cheminių produktų registracija, įvertinimas, autorizavimas ir apribojimas (EB) Nr. 1907/2006 (REACH)

ES atitikties deklaraciją galite atsisiųsti iš <https://en.goodwe.com>.

For more information, scan the QR codes below.



SolarGo App



SolarGo User Manual



SEMS Portal App



SEMS Portal app User Manual

07 Tehniskie dati**LV**

	Modelis	Ezlink3000
Vispārīgie parametri	Savienojuma Saskarne	USB
	Ethernet Saskarne (Pēc izvēles)	10/100Mbps pašadapters, Komunikāciju distance ≤100m
	Uzstādīšana	Pieslēgt and atskaņot
	Indikators	LED indikators
	Izmēri (P × A × Dz mm)	49 × 153 × 32
	Svars (g)	130
	Iekļūšanas aizsardzības vērtējums	IP65
	Elektroenerģijas patēriņš (W)	≤2
	Darbības režīms	STA
Bezvadu Parametri	Bluetooth	Bluetooth 5.1
	Bezvadu Komunikācija	802,11 b/g/n(2,412GHz-2,484GHz)
Apkārtējā vide Parametri	Darbības temperatūras diapazons (°C)	-30 ~ +60
	Uzglabāšanas temperatūras diapazons (°C)	-30 ~ +70
	Relatīvais mitrums	0-100% (bez kondensācijas)
	Maks. ekspluatācijas augstums (m)	4000

08 ES Atbilstības deklarācija**LV**

Līdz ar to, GoodWe Technologies Co., Ltd. paziņo, ka Eiropas tirgū pārdošanā atrodamā komunikāciju ierīce atbilst sekojošo direktīvu prasībām:

- Radio Iekārtu Direktīva 2014/53/ES (RED)
- Bīstamo vielu ierobežošanas direktīva 2011/65/EU un (EU) 2015/863 (RoHS)
- Elektrisko un elektronisko iekārtu atkritumi 2012/19/ES
- Ķīmikāliju reģistrēšanas, vērtēšanas, licencēšanas un ierobežošanas regula (EK) Nr. 1907/2006 (REACH)

Jūs varat lejupielādēt ES atbilstības deklarāciju vietnē <https://en.goodwe.com>.

For more information, scan the QR codes below.



SolarGo App

SolarGo User
ManualSEMS Portal
AppSEMS Portal app
User Manual

07 Technische gegevens**NL**

	Model	Ezlink3000
Algemene parameters	Verbindingsinterface	USB
	Ethernet-interface (optioneel)	10/100 Mbps zelfaanpassing, communicatieafstand ≤100 m
	Installatie	Plug-and-play
	Indicator	Led-indicator
	Afmetingen (B × H ×D mm)	49 × 153 × 32
	Gewicht (g)	130
	Beschermingsklasse tegen insijpelen	IP65
	Stroomverbruik (W)	≤2
	Bedrijfsmodus	STA
Draadloos parameters	Bluetooth	Bluetooth 5.1
	WiFi-communicatie	802.11 b/g/n (2,412 GHz-2,484 GHz)
Milieu parameters	Bedrijfstemperatuurbereik (°C)	-30 ~ +60
	Opslagtemperatuurbereik (°C)	-30 ~ +70
	Relatieve vochtigheid	0-100% (niet condenserend)
	Max. gebruikshoogte (m)	4000

08 EU-conformiteitsverklaring**NL**

GoodWe Technologies Co., Ltd. verklaart hierbij dat het communicatieapparaat dat wordt verkocht op de Europese markt, voldoet aan de vereisten van de volgende richtlijnen:

- Richtlijn inzake radioapparatuur 2014/53/EU (RED)
- Richtlijn inzake de beperking van gevaarlijke stoffen 2011/65/EU en (EU) 2015/863 (RoHS)
- Elektrisch en elektronisch afval 2012/19/EU
- Registratie, evaluatie, autorisatie en beperking van chemicaliën (EC) Nr 1907/2006 (REACH)

U kunt de EU-conformiteitsverklaring downloaden op <https://en.goodwe.com>.

For more information, scan the QR codes below.



SolarGo App



SolarGo User Manual



SEMS Portal App



SEMS Portal app User Manual

07 Dane techniczne**PL**

	Model	Ezlink3000
Parametry ogólne	Interfejs połączenia	USB
	Interfejs Ethernet (opcjonalnie)	10/100 Mbps samodostosowanie, Długość kabli sygnalizacyjnych ≤100 m
	Instalacja	Plug-and-play
	Wskaźnik	Wskaźnik diodowy
	Wymiary (szer. × wys. × gł., mm)	49 × 153 × 32
	Ciężar (g)	130
	Stopień ochrony	IP65
	Pobór mocy (W)	≤2
Bezprzewodowy Parametry	Tryb pracy	STA
	Bluetooth	Bluetooth 5.1
Środowisko Parametry	Komunikacja Wi-Fi	802.11 b/g/n(2.412 GHz-2.484 GHz)
	Zakres temperatury pracy (°C)	-30 ~ +60
	Zakres temperatury przechowywania (°C)	-30 ~ +70
	Wilgotność względna	0-100% (bez kondensacji)
	Maks. wysokość pracy n.p.m. (m)	4000

08 Deklaracja zgodności UE**PL**

Firma GoodWe Technologies Co., Ltd. niniejszym oświadcza, że urządzenie do komunikacji bezprzewodowej, sprzedawane na rynku europejskim, spełnia wymagania następujących dyrektyw:

- Dyrektywa w sprawie urządzeń radiowych 2014/53/UE (RED)
- Dyrektywa w sprawie ograniczenia stosowania substancji niebezpiecznych 2011/65/UE i dyrektywa (UE) 2015/863 (RoHS)
- Zużyty sprzęt elektryczny i elektroniczny 2012/19/UE
- Rozporządzenie (WE) nr 1907/2006 ws. rejestracji, oceny, udzielania zezwoleń i ograniczenia stosowania chemikaliów (REACH)

Unijną deklarację zgodności można pobrać ze strony <https://en.goodwe.com>.

For more information, scan the QR codes below.



SolarGo App



SolarGo User Manual



SEMS Portal App



SEMS Portal app User Manual

07 Dados técnicos**PT**

Modelo		Ezlink3000
Parâmetros gerais	Interface de conexão	USB
	Interface Ethernet (opcional)	Autoadaptação de 10/100 Mbps, distância de comunicação ≤ 100 m
	Instalação	Plug and Play
	Indicador	Indicador de LED
	Dimensões (L × A × P mm)	49 × 153 × 32
	Peso (g)	130
	Classificação de proteção de entrada	IP65
	Consumo de energia (W)	≤ 2
Parâmetros sem fio	Bluetooth	Bluetooth 5.1
	Comunicação Wi-Fi	802,11 b/g/n (2,412 GHz a 2,484 GHz)
Parâmetros do ambiente	Faixa de temperatura operacional (°C)	-30 a +60
	Faixa de temperatura de armazenamento (°C)	-30 a +70
	Umidade relativa	0 a 100% (sem condensação)
	Altitude máxima de operação (m)	4.000

08 Declaração de Conformidade da UE**PT**

A GoodWe Technologies Co., Ltd. declara que o dispositivo de comunicação vendido no mercado europeu atende aos requisitos das seguintes diretivas:

- Diretiva de Equipamentos de Rádio 2014/53/EU (RED)
- Diretiva de Restrições de Substâncias Perigosas 2011/65/EU e (UE) 2015/863 (RoHS)
- Resíduos de Equipamentos Elétricos e Eletrônicos 2012/19/EU
- Registro, Avaliação, Autorização e Restrição de Produtos Químicos (EC) N° 1907/2006 (REACH)

Baixa a Declaração de Conformidade da UE em <https://en.goodwe.com>.

For more information, scan the QR codes below.



SolarGo App

SolarGo User
ManualSEMS Portal
AppSEMS Portal app
User Manual

07 Date tehnice**RO**

	Model	Ezlink3000
Parametri generali	Interfața de conexiune	USB
	Interfață Ethernet (opțională)	Auto-adaptare 10/100 Mbps, Distanță de comunicare ≤100 m
	Instalare	Conectare și utilizare
	Indicator	Indicator LED
	Dimensiuni (L x Î x L mm)	49 × 153 × 32
	Greutate (g)	130
	Grad de protecție contra penetrațiilor	IP65
	Consum de putere (W)	≤2
	Mod de operare	STA
Wireless Parametri	Bluetooth	Bluetooth 5.1
	Comunicare WiFi	802.11 b/g/n(2.412GHz-2.484GHz)
Mediu Parametri	Interval de temperaturi de lucru (°C)	-30 ~ +60
	Interval de temperaturi de depozitare (°C)	-30 ~ +70
	Umiditate relativă	0-100% (fără condens)
	Altitudine max. de lucru (m)	4000

08 Declarație de conformitate UE**RO**

GoodWe Technologies Co., Ltd. declară prin prezenta că dispozitivul de comunicare comercializat pe piața europeană îndeplinește cerințele următoarelor directive:

- Directiva privind echipamentele radio 2014/53/UE (RED)
- Directiva privind restricționarea substanțelor periculoase 2011/65/UE și (UE) 2015/863 (RoHS)
- Deșeurile de echipamente electrice și electronice 2012/19/UE
- Înregistrarea, evaluarea, autorizarea și restricționarea substanțelor chimice (CE) nr 1907/2006 (REACH)

Puteți descărca Declarația de conformitate UE la adresa <https://en.goodwe.com>.

For more information, scan the QR codes below.



SolarGo App



SolarGo User Manual



SEMS Portal App



SEMS Portal app User Manual

07 Technické údaje**SK**

	Model	Ezlink3000
Všeobecné parametre	Rozhranie pripojenia	USB
	Ethernet rozhranie (Voliteľné)	Samoprispôsobenie 10/100 Mbps Komunikačná vzdialenosť ≤100m
	Inštalácia	Technológia Plug and Play
	Indikátor	LED indikátor
	Rozmery (Š × V × H mm)	49 × 153 × 32
	Hmotnosť (g)	130
	Stupeň krytia	IP65
	Spotreba energie (W)	≤2
Bezdrôtový Parametre	Operačný mód	STA
	Bluetooth	Bluetooth 5.1
Prostredie Parametre	Wi-Fi komunikácia	802,11 b/g/n(2,412GHz-2,484GHz)
	Rozsah prevádzkových teplôt (°C)	-30 ~ +60
	Rozsah teploty skladovania (°C)	-30 ~ +70
	Relatívna vlhkosť	0-100% (bez kondenzácie)
	Max. prevádzková nadmorská výška (m)	4 000

08 Vyhlásenie o zhode EÚ**SK**

Spoločnosť GoodWe Technologies Co., Ltd. týmto vyhlasuje, že menič s modulmi bezdrôtovej komunikácie predávaný na európskom trhu spĺňa požiadavky nasledujúcich smerníc:

- Smernica o rádiovom zariadení 2014/53/EU (ČERVENÁ)
- Smernica o obmedzeniach nebezpečných látok 2011/65/EU a (EU) 2015/863 (RoHS)
- Odpad z elektrických a elektronických zariadení 2012/19/EÚ
- Číslo registrácie, hodnotenia, autorizácie a obmedzenia chemikálií (EC) No 1907/2006 (REACH)

Vyhlásenie o zhode EÚ si môžete stiahnuť na <https://en.goodwe.com>.

For more information, scan the QR codes below.



SolarGo App

SolarGo User
ManualSEMS Portal
AppSEMS Portal app
User Manual

07 Tehnični podatki**SL**

	Model	Ezlink3000
Splošni parametri	Povezovalni vmesnik	USB
	Vmesnik Ethernet (neobvezno)	Samodejno prilagajanje 10/100 Mb/s, Razdalja komuniciranja ≤100m
	Namestitev	Vklopi-in-igraj
	Indikator	LED Indikator
	Dimenzije (Š×V×G mm)	49 × 153 × 32
	Teža (g)	130
	Stopnja Zaščite Pred Vdori	IP65
	Poraba energije (W)	≤2
	Način delovanja	STA
Wireless Parametri	Bluetooth	Bluetooth 5.1
	Komunikacija WiFi	802,11 b/g/n(2,412GHz-2,484GHz)
Okolje Parametri	Območje Delovne Temperature (°C)	-30 ~ +60
	Območje Temperature Shranjevanja (°C)	-30 ~ +70
	Relativna vlažnost	0-100% (nekondenzirajoča)
	Maks. Delovna Višina (m)	4000

08 EU Izjava o skladnosti**SL**

GoodWe Technologies Co., Ltd. izjavlja, da pretvornik z komunikacijska naprava, ki se prodaja na evropskem trgu, izpolnjuje zahteve naslednjih direktiv:

- Direktiva o radijski opremi 2014/53/EU (RED)
- Omejitve direktive o nevarnih snoveh 2011/65/EU in (EU) 2015/863 (RoHS)
- Odpadna električna in elektronska oprema 2012/19/EU
- Registracija, evalvacija, avtorizacija in omejevanje kemikalij (ES) št. 1907/2006 (REACH)

Izjava EU o skladnosti lahko prenesete na <https://en.goodwe.com>.

For more information, scan the QR codes below.



SolarGo App



SolarGo User Manual



SEMS Portal App



SEMS Portal app User Manual

07 Tekniska data

SV

	Modell	Ezlink3000
Allmänna parametrar	Anslutningsgränssnitt	USB
	Ethernet-gränssnitt (valfritt)	10/100 Mbps självanpassning, Kommunikationsavstånd ≤100m
	Installation	Anslut och använd
	Indikator	LED-indikator
	Mått (b x h x d)	49 x 153 x 32
	Vikt (g)	130
	Klassificering av intrångsskydd	IP65
	Effektförbrukning (W)	≤2
Trådlös Parametrar	Driftläge	STA
	Bluetooth	Bluetooth 5.1
Miljö Parametrar	WiFi-kommunikation	802,11 b/g/n(2,412GHz-2,484GHz)
	Drifttemperaturområde (°C)	-30 ~ +60
	Förvaringstemperatur (°C)	-30 ~ +70
	Relativ fuktighet	0-100% (icke-kondenserande)
	Max. Driftshöjd (m)	4000

08 EU-försäkran om överensstämmelse

SV

GoodWe Technologies Co., Ltd. förklarar härmed att den kommunikationsutrustning som säljs på den europeiska marknaden uppfyller kraven i följande direktiv:

- Direktiv om radioutrustning 2014/53/EU (RED)
- Direktivet om begränsning av farliga ämnen 2011/65/EU och (EU) 2015/863 (RoHS)
- Avfall av elektrisk och elektronisk utrustning 2012/19/EU
- Registrering, utvärdering, godkännande och begränsning av kemikalier (EG) nr 1907/2006 (REACH)

Du kan ladda ner EU:s försäkran om överensstämmelse på <https://en.goodwe.com>.

For more information, scan the QR codes below.



SolarGo App



SolarGo User Manual



SEMS Portal App



SEMS Portal app User Manual



Website

GoodWe Technologies Co., Ltd.

 No. 90 Zijin Rd., New District, Suzhou, 215011, China

 www.goodwe.com

 service@goodwe.com



340-00999-00



Local Contacts